

LLLLLLLL
LLLLLLLL
LLLLLLLL
LUX ELEMENTS®
LLLLLLLL



LUX ELEMENTS – The Construction

Designing with hard foam support elements

LLLLLLLL
LLLLLLLL
LLLLLLLL
LUX ELEMENTS
LLLLLLLL

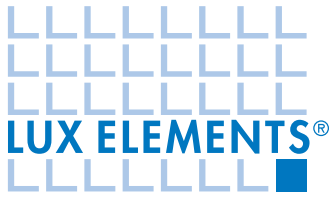

Welcome to LUX ELEMENTS

True to our motto, 'Solutions for modern building design', our medium-sized family business based in Leverkusen, Germany, has been producing hard foam support elements for moist and wet areas for more than three decades. Founded back in 1945 as a tiling company, we have based our development of this modern building material on the practical experience we have gained processing tiles every day.

Our range of products extends from construction panels and standardised system building kits to constructions for wellness and bathing environments. Due to their special material properties, hard foam support elements are ideally suitable for bathroom design. Subsequent tiling with ceramics as desired adds a final personal flair to any room.



LUX ELEMENTS – The Construction

Content

Solutions for modern building design

The way to your dream bathroom	4
High material quality and environmentally-friendly production	6
The best choice for your bathroom	8
Bathroom constructions with hard foam support elements	10

Wall claddings, floor structures and design elements

The universal construction panel for walls and floors	12
The pre-slit construction panel for round shapes	26
The multi-functional construction panel	30
LUX ELEMENTS®-ELEMENT – Programme summary	34

Installation claddings

Cladding elements – cladding of pipes	38
Cladding of wall-mounted constructions	39
LUX ELEMENTS®-TEC – Programme summary	40

Bath surrounds

Bath tub surrounds	44
Whirlpool surrounds	46
LUX ELEMENTS®-TOP – Programme summary	48

Washstands

Washstands – Variants	52
LUX ELEMENTS®-LAVADO – Programme summary	54

Processing and design

Tools, techniques and accessories	58
Sealing – Connection to a shower area	68
Processing tips	70
Alternative surfaces	72
Light fascination	74

The way to your dream bathroom

Perfect planning – reliable implementation

From the idea to reality

Congratulations! The plans for the new bathroom are finally finished. Thanks to modern planning software, a realistic draft has emerged from an individual idea: this is how beautiful it's going to look like! But before tiling, the substrate needs to be prepared with the suitable material. It would be great if that was easy, clean and fast...

Renovation or new building

Whether new building or renovation – an ideal material for the bathroom is called for. The demands are high: the material must be waterproof and pressure-stable. A light weight is also of advantage, for example when the support structure of the building must not be subjected to more stress. Or when working in old buildings where there are no lifts, but steep stairs – who really wants to drag stones, cement and mortar?!





Fast and reliable

Short processing and drying times are important aspects when finishing a bathroom, and in particular when renovating a bathroom, because you want it finished as soon as possible: even if it has unusual designs and round shapes for the walls or claddings. Nobody wants to be without their bathroom for long.



Long-term well being

You want the bathroom to stay as beautiful as it was when it was first finished. This is ensured by a mould-resistant substrate that your health benefits from. An additional heat insulating building material is easy on your wallet. And if the material used has been produced with the environment in mind, then that good feeling is perfect in all respects.



Isn't it good that our hard foam support elements can fulfil all of those requirements? On the next pages we will explain why.

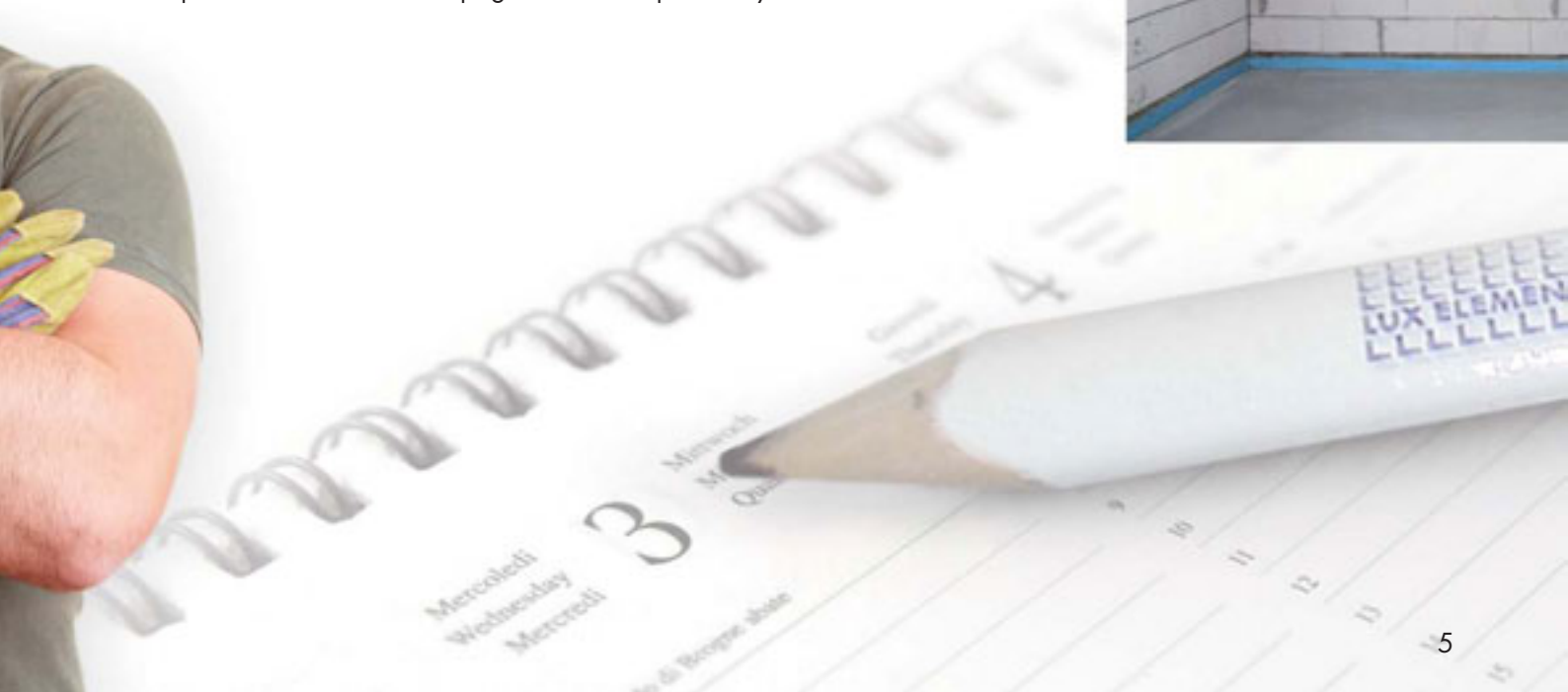



LUX ELEMENTS – Solutions for modern building design

Hard foam support elements

High material quality and environmentally-friendly production

The basic material for the flush with the floor shower bases of LUX ELEMENTS is LUX ELEMENTS®-FOAM, a very high-quality, blue coloured, expanded polystyrene hard foam with high density that is produced using an environmentally friendly technique without foaming agents which are harmful to the climate. The moisture-resistant material is ideally suitable for use in bathrooms.

During further processing, the hard foam becomes a hard foam support element with a special mortar coating on both sides. For increased rigidity values a glass-fibre fabric is additionally embedded in the mortar coating.

No chance for mould – biological behaviour

LUX ELEMENTS®-FOAM does not provide a breeding ground for micro-organisms. It does not rot or get mouldy. FOAM is neither harmful to the environment nor hazardous to water.

The safety of FOAM is made most obvious by the fact that the same raw-material is used to make food packaging. In its composition, the EPS FOAM fulfils the recommendation V polystyrene of the German Federal Health Office.



“The Original – LUX ELEMENTS®
hard foam support element” –
this pioneering invention in tiling
was patented 1981 by Herbert Lux.

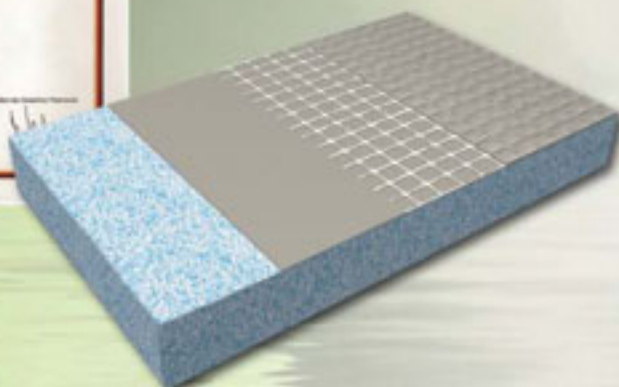

Proven material advantages

The original can do!

Hard foam support elements from LUX ELEMENTS are characterised by particular material properties, which are of particular advantage for use in wet and humid conditions.



■ environmentally friendly



■ proven quality

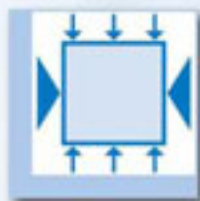

■ pressure-stable and rigid



■ lightweight



■ waterproof



■ fire-retarding



■ insulating



■ mould-resistant



■ design variety



■ alternative surfaces



■ economical



■ system-oriented

Since more than 30 years hard foam support elements from LUX ELEMENTS have been successful in practical use and have proved themselves there to this day. As a modern building material, the ORIGINAL must fulfil high requirements. This includes always meeting current technical standards and trends and being flexible. This is why we place great importance on continuous development of the ORIGINAL and the extension of a modern, system-oriented product range.



NOTE:

Would you like to learn more?
Please see:

www.the-original-can-do.com





The
ORIGINAL
can do!

LUX ELEMENTS – Solutions for modern building design

The best choice for your bathroom: Hard foam support elements from LUX ELEMENTS

The new generation of environment-friendly hard foam support elements is more than a construction panel in different thicknesses.

It is a modern building material which, due to its excellent physical characteristics in combination with very good processing ability, creates freedom for planners, designers, craftsmen and companies who do not want to be limited by conventional methods.

- **Easier**
Perfect fit thanks to prefabricated components
- **Faster**
Short drying times of adhesives and mortar
- **Cleaner**
Dry material, easy to process
- **More reliable**
Tested system of parts and system components
- **More imaginative**
Special designs and cut-to-size elements easily possible

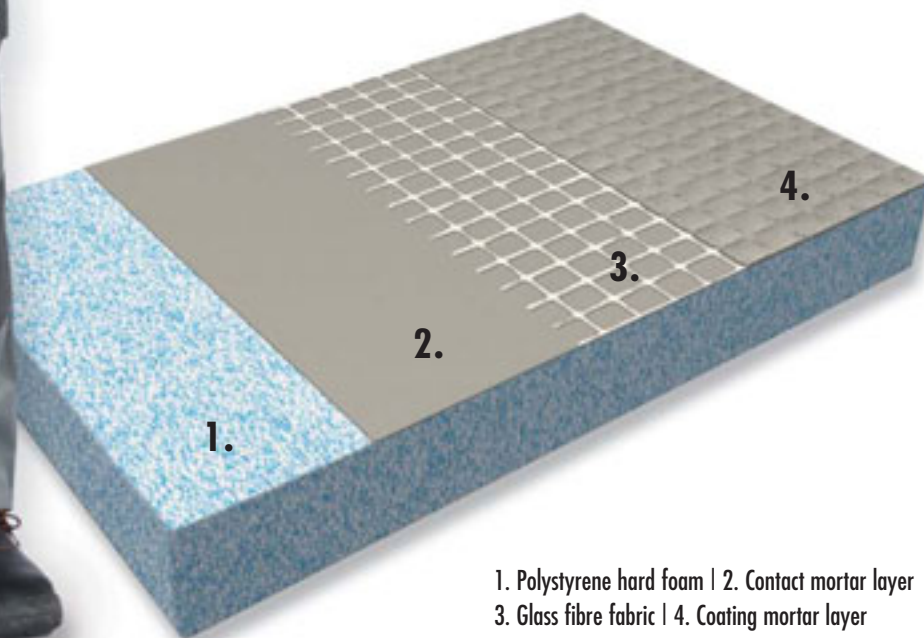
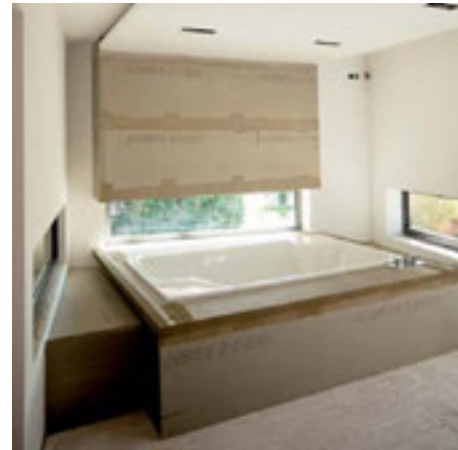

1. Polystyrene hard foam | 2. Contact mortar layer
3. Glass fibre fabric | 4. Coating mortar layer

Bathroom constructions with hard foam support elements

**Reliable on the wall, strong on the floor
and suitable for multi-functional uses**

Individual dream bathrooms can be designed to any wishes with LUX ELEMENTS hard foam support elements. The products are used nearly everywhere in the bathroom. Each bathroom becomes unique thanks to the final surface finish with ceramics or plaster, depending on your personal taste.

The next pages of this brochure provide further information on working with hard foam support elements in bathroom construction.



■ **LUX ELEMENTS®-ELEMENT –**
Wall claddings, floor structures
and design elements

from page 10 onward

The construction panels from the ELEMENT product group are available in many thicknesses and designs for different areas of application. They are suitable for use on the wall, as well as on the floor. Thicker panels are suitable for the design of platforms, steps and shelves. Apart from the straight version there are vertically and horizontally slit variants that can be bent into round shapes. The factory-sealed product ELEMENT-VK with vapour-barrier properties is available for applications requiring sealing.

NOTE:

For further information, please refer to our brochure "The Experience – Shower bases" and "Individual concepts – Customised and special products".



■ LUX ELEMENTS®-TEC – The installation claddings

from page 36 onward

Items from product group TEC are ideal for the easy, fast and clean cladding of bathroom installations. These include vertical or horizontal pipes in corners or on straight surfaces, which can be easily covered with the prefabricated pipe cladding elements.

Furthermore, a building kit for conventional wall-mounted constructions is offered under the designation TEC-VWD. This can be easily adapted to various sizes and comprises all necessary components including assembly material.



■ LUX ELEMENTS®-TOP – Bath surrounds

from page 42 onward

The product group TOP comprises solutions for the cladding of standard bath tubs and whirlpools. The building kits for bathtub claddings cover all thinkable installation situations, whether free-standing or in a niche or corner. In order to enable cleaning and access to the fittings, two optional maintenance opening options are available for these products.

TOP-WP ... is a completely removable cladding for whirlpools in four different sizes or made to measure.



■ LUX ELEMENTS®-LAVADO – The Washstands

from page 50 onward

LAVADO is the product group for tileable and therefore individual washstands in sophisticated design. Due a strong, invisible suspension, the models with the designation LAVADO-FLOAT look as though they are floating. Three washstands have a pre-shaped trough in which the water drains off. The fourth model is flat, without a trough, and is thus suitable for conventional fitted or top-mounted basins. The flexible height is practical for personal requirements.



■ Processing and design – Techniques and accessories

from page 56 onward

Would you like to know more about construction with LUX ELEMENTS hard foam support elements?

Here you will find information about tools, processing techniques and accessories as well as tips for connection to the shower area.

Expert information, clear and with many illustrations.

LUX ELEMENTS also offers all necessary system components.



LUX ELEMENTS – The Construction

Designing with hard foam support elements

ELEMENT-EL

The universal construction panel for walls and floors

ELEMENT-EL is a support element made of polystyrene hard foam with mortar coating and glass fibre fabric on both sides.

The construction panels are available in up to ten thickness grades and two lengths. Due to its size, the shorter version, also called "Baby panel" or "One-man panel", is particularly easy to handle and is also suitable for floor installation.



Ready for tiling, easy-to-use and versatile in everyday practice. Using ELEMENT to make substrates for thin-bed laying is just as problem-free as any of the processes involving design, construction, cladding, insulation and sealing.



LUX ELEMENTS®-ELEMENT-PLUS

LUX ELEMENTS manufactures individual customised and special products for the ELEMENT product group. These include dimensions, thicknesses, shapes etc. that deviate from the standard program. For more information see page 35.







LUX ELEMENTS – The Construction

Designing with hard foam support elements

ELEMENT-EL

Wall cladding on masonry, concrete and plaster

The universal construction panel ELEMENT-EL is outstandingly well suited for wall mounting. Installation on masonry, concrete and plaster is particularly simple. This creates a perfect substrate for tiles and plasters that is waterproof, mould-resistant and heat insulating.

LUX ELEMENTS also offers all fully adapted system components such as fixing adhesive, reinforcement fabric and wall plugs.

The dot technique is usually applied from a construction panel thickness of 6 mm. After inspection of the substrate for load-bearing capacity, holes are pre-pierced using a cross slot screwdriver in the later position of the mortar dots for the wall plugs. Subsequently, apply the fixing adhesive COL-AK in dots on one side of the construction panel and glue it to the wall.

Alignment then takes place by slight pressure on the mortar dots. Wall plugs are then forced into the pre-pierced holes and all element joints are reinforced with ARM-100 SK self-adhesive glass fibre reinforcement strips.

After the strips have been levelled out with fixing COL-AK fixing adhesive the surface is ready for tiling.

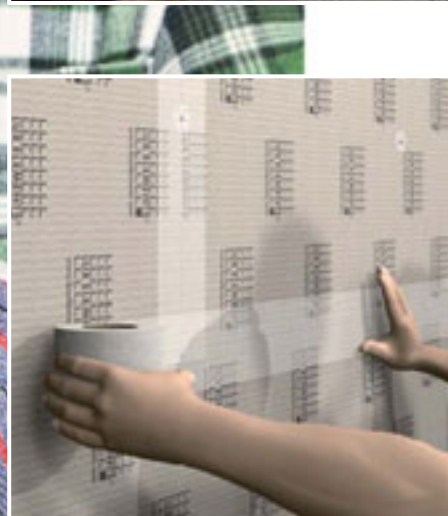
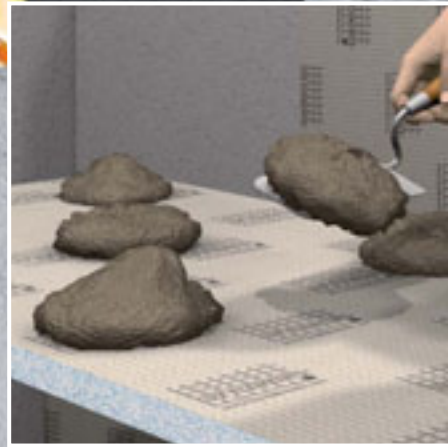

Note:

Technical details and accessories from page 56 onward.

For further information, please refer to our documents on www.luxelements.com



LUX ELEMENTS – The Construction

Designing with hard foam support elements



Note:

Technical details and accessories from page 56 onward. For further information, please refer to our documents on www.luxelements.com



ELEMENT-EL

Wall levelling over existing tile coverings

Wall levelling over old tiles also belongs to the classic wall applications. If the old tile covering has only been done half way up the wall, then levelling is necessary above to enable the entire wall to be re-tiled. LUX ELEMENTS offers thin construction panels from a thickness of 4 mm for exactly this purpose.

Before beginning with the actual installation the first step is to check the substrate for its load-bearing capacity. After this the COL-AK fixing adhesive is applied to the construction panel: when using ELEMENT-EL Baby 4 elements, coating always takes place over the full surface using a notched trowel; when using ELEMENT ≥ 6 mm elements, adhesive dots are applied. In the next step the construction panels are positioned at the top edge of the old tile coverings and pressed against the wall.

Alignment with a straight edge and a level is followed by a short drying period of three hours. If required, the wall panels are additionally anchored with wall plugs. For this purpose LUX ELEMENTS offers different wall plugs and fastening sets.

Finally, the joints and transitions need to be reinforced with glass fibre reinforcement strips and levelled out – and the substrate is ready for the new tiles!

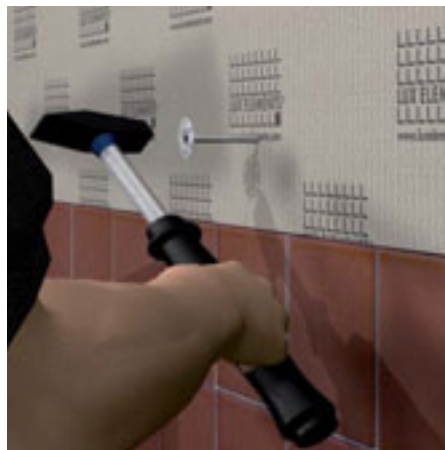
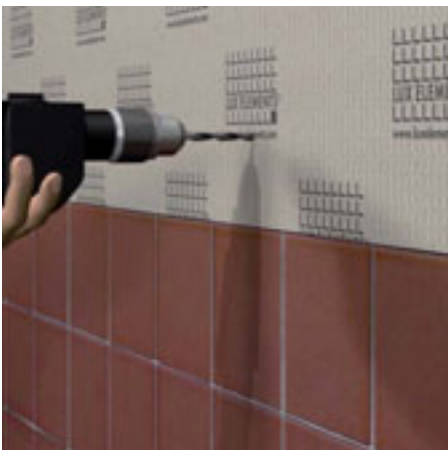

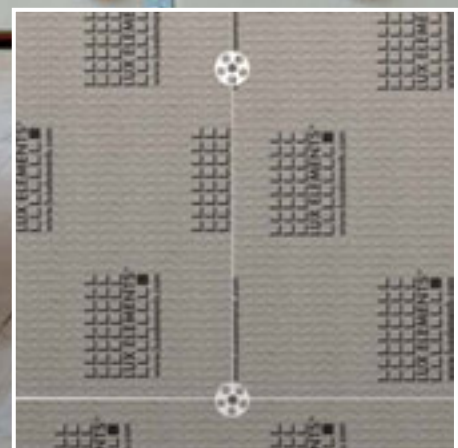
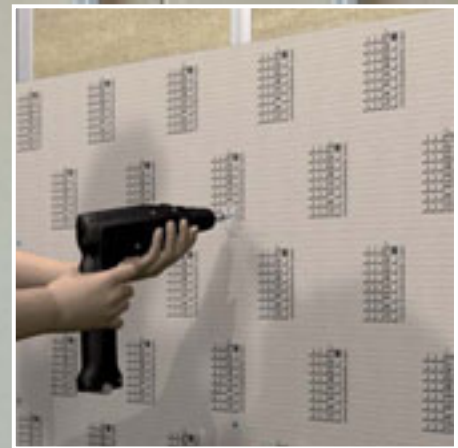
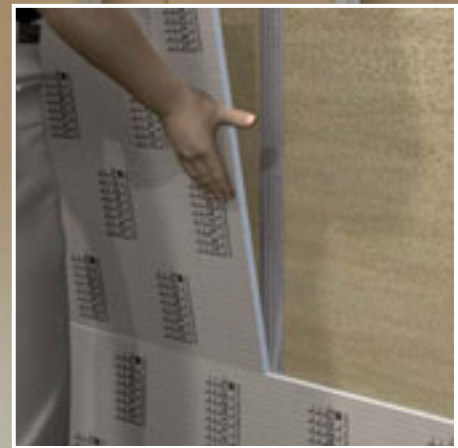
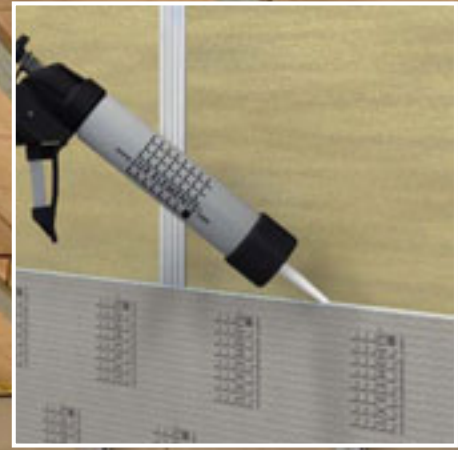

NOTE:

National directives/
approvals must be
observed for this
application, e.g. for
the spacing of laths and
subsequent sealing.

LUX ELEMENTS – The Construction

Designing with hard foam support elements

ELEMENT-EL

Wall cladding on stud frames

Fast and flexible

The installation of construction panels on stud frames is very popular and frequently applied. This method not only enables walls to be created in a very short time – later disassembly is also possible very quickly and without causing a lot of dirt.

There are generally three different types of stud frame applications:

- Doubling on an existing wall
- Free-standing walls on metal stud frame
- Free-standing walls on wooden stud frame

Processing is identical for all applications.

After the stud frame has been finished as the substructure, the ELEMENT panels are laid in bond from a thickness of 10 mm and fastened with suitable screws. Adhesion of the construction panels to one another takes place additionally using the mounting adhesive COL-MK. (see also page 61)



LUX ELEMENTS – The Construction

Designing with hard foam support elements

ELEMENT-EL

Designing and construction

Construction panels from the ELEMENTEL product group are real all-rounders. The field of application for these products stretches far beyond standard applications.

During processing, the construction panels are cut into suitable shaped elements with conventional tools and reliably processed using the system-compliant adhesives, wall plugs and mounting aids made by LUX ELEMENTS. This is followed by reinforcement of all ELEMENT joints with glass fibre reinforcement strips. The last step is to level out the reinforced joints with fixing adhesive COL-AK and the element is ready. Now all that is missing is the tiling or plaster in your personal favourite colour!

Applications

- The thicker construction panels between 30 and 100 mm are particularly suitable for the individual construction of bathroom design elements such as shelves, platforms, steps and room dividers, for example.
- Made-to-measure claddings of wall-mounted installations or bath tubs can be quickly made of construction panels.

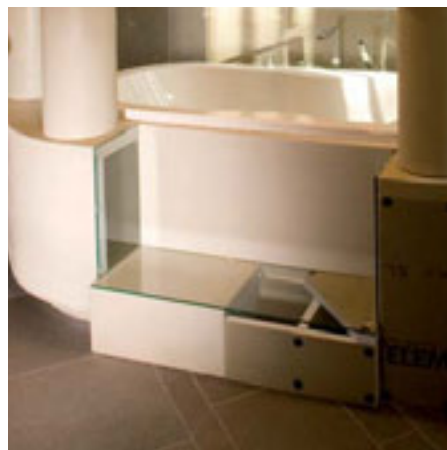



Note:
Technical details and accessories from page 56 onward.
For further information, please refer to our documents on www.luxelements.com





LUX ELEMENTS – The Construction

Designing with hard foam support elements

ELEMENT-EL

Floor structures on wooden floor boards

Preparation

The shorter Baby construction panels from ELEMENT-EL Baby 4 are suitable for this application. The substrate must be able to support loads and vibration-free. Loose boards must be re-screwed and rotten boards must be replaced. Irregularities must be compensated using levelling filler.

Applications

After preparation of the substrate, stick edge insulation strips circumferentially round all wall-floor connections, before the ELEMENT panels are laid offset in bond. These are then fastened to the wooden floor with the suitable LUX ELEMENTS screws. Full-surface adhesion is also possible on a wooden floor pre-primed with COL-HSV. In the next workstep the joints are reinforced with glass fibre reinforcement strips and then levelled out.

In damp or wet rooms it is necessary to use an additional DRY-ASK tape sealer or DRY-DF sealing film in conjunction with ceramic coverings. ELEMENT-VK can also be used as an alternative (from page 30).

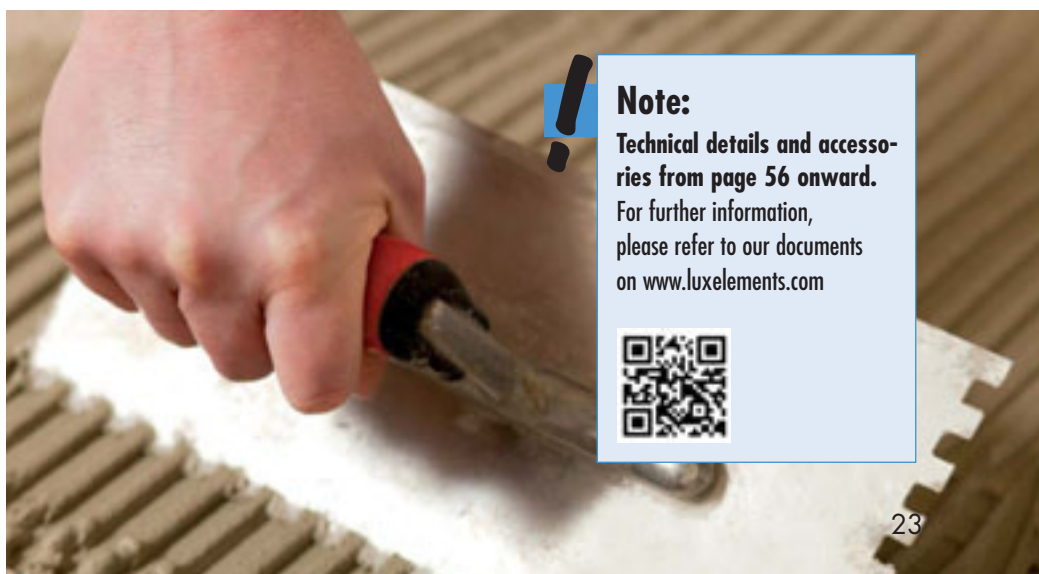
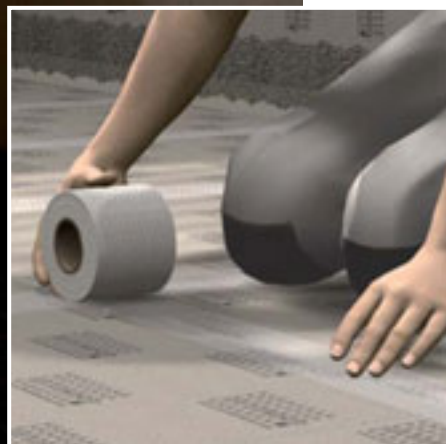
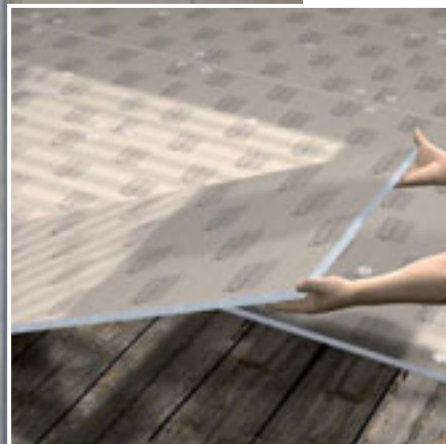

Note:

Technical details and accessories from page 56 onward.

For further information, please refer to our documents on www.luxelements.com



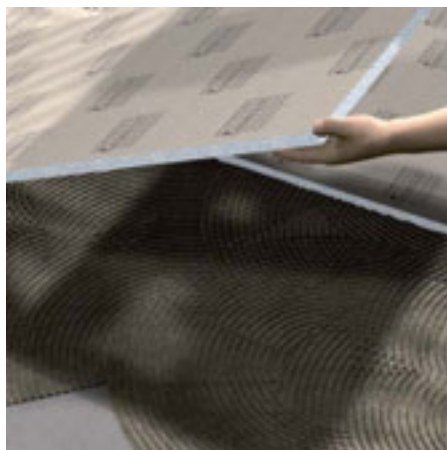
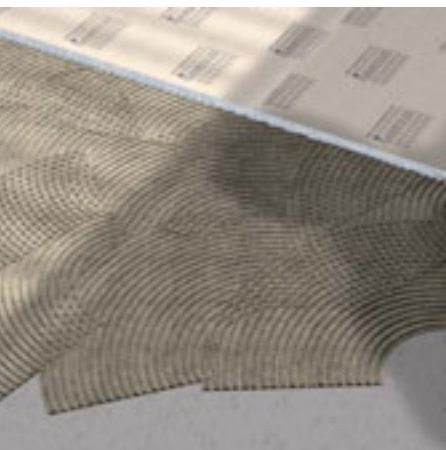

LUX ELEMENTS – The Construction

Designing with hard foam support elements

ELEMENT-EL

Floor structures on concrete or screed

Applications

First of all the substrate must be prepared and the application of the edge insulating strip is necessary as for floor application on wooden boards (page 23). This is followed by the laying of the ELEMENT construction panels. Baby construction panels from ELEMENT-EL Baby 4 are recommended.

For thickness grades \leq EL 30 the fixing adhesive COL-AK is evenly applied to the floor using a notched trowel. The ELEMENT panels are positioned close together in bond and pressed into the adhesive layer. Dot laying is possible from EL 30.

Application on underfloor heating

The physical characteristics of ELEMENT construction panels include amongst other things a temperature resistance up to 75 °C. This is why floor applications with ELEMENT-EL can be ideally combined with underfloor heating systems.

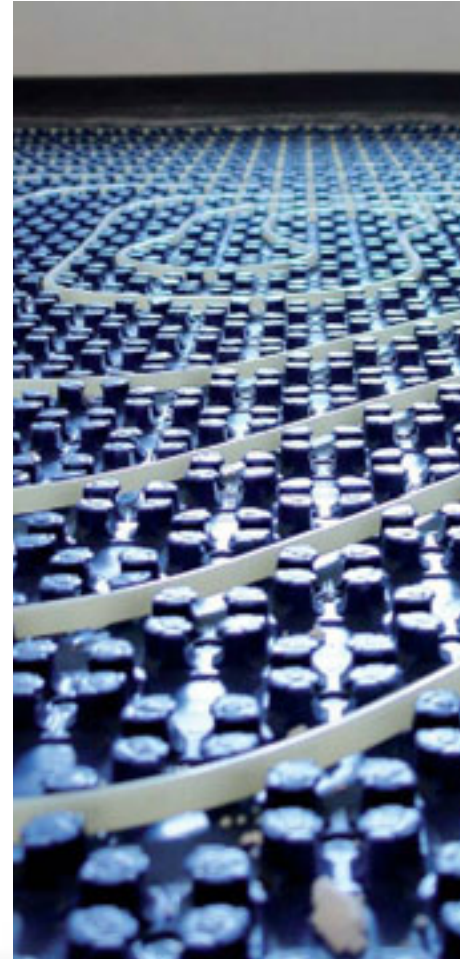

Note:

Technical details and accessories from page 56 onward.

For further information, please refer to our documents on www.luxelements.com





LUX ELEMENTS – The Construction Designing with hard foam support elements

ELEMENT-SL and -SQ

The pre-slit construction panel for round shapes

ELEMENTS-SL and -SQ are pre-slit hard foam support elements, which allow a flexible, fast and clean design of round shapes.

Available in designs vertically slit (SL) and horizontally slit (SQ), each in three different thicknesses.



LUX ELEMENTS®-ELEMENT-PLUS

LUX ELEMENTS manufactures individual customised and special products for the ELEMENT product group. These include dimensions, thicknesses, shapes etc. that deviate from the standard program. For more information see page 35.

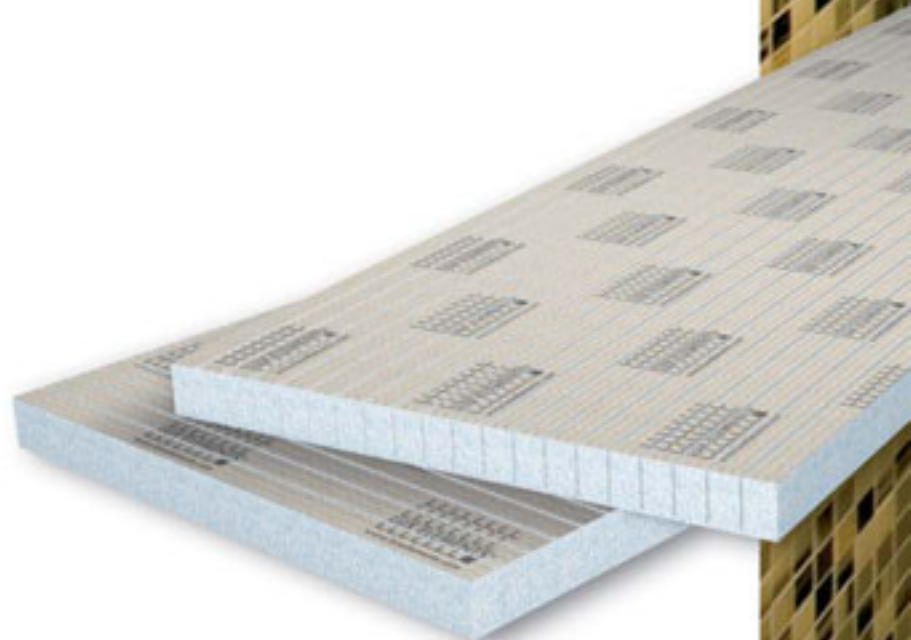

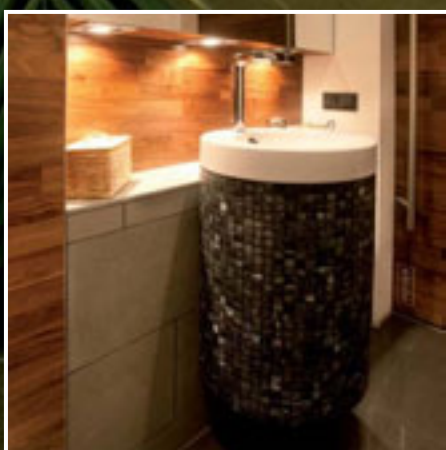
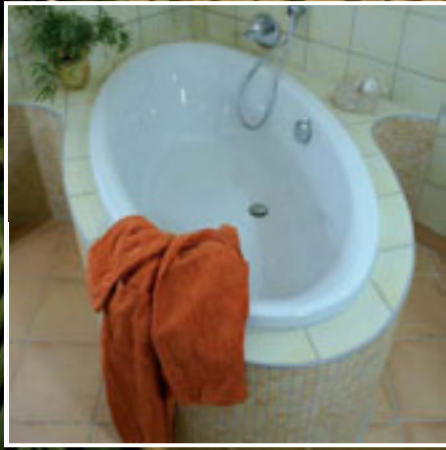



Note:

Technical details and accessories from page 56 onward.

For further information, please refer to our documents on www.luxelements.com



LUX ELEMENTS – The Construction

Designing with hard foam support elements

ELEMENT-SL and -SQ

here we go
with pre-slit panels ...

Apart from the universal ELEMENT construction panel in ten thicknesses, LUX ELEMENTS offers two pre-slit variants in three thicknesses. Due to the slitting of these hard foam support elements at even intervals, they can be easily bent and formed into circular shapes. These can be used anywhere where a simple curve is required. For example when designing round partition walls, bathtub claddings or wall-mounted elements.

Where the slit hard foam support elements reach the end of their technical limits due to their thickness and bending radius, LUX ELEMENTS offers other product groups:

- LUX ELEMENTS®-CONCEPT – the individual concepts
Special models according to requirements, even for solid shapes, which are multi-dimensionally rounded.
- LUX ELEMENTS®-DECO – the decorative elements
e.g. concave trims, solid pillars and rounding elements for equipping, cladding or extending rooms, room corners and walls.

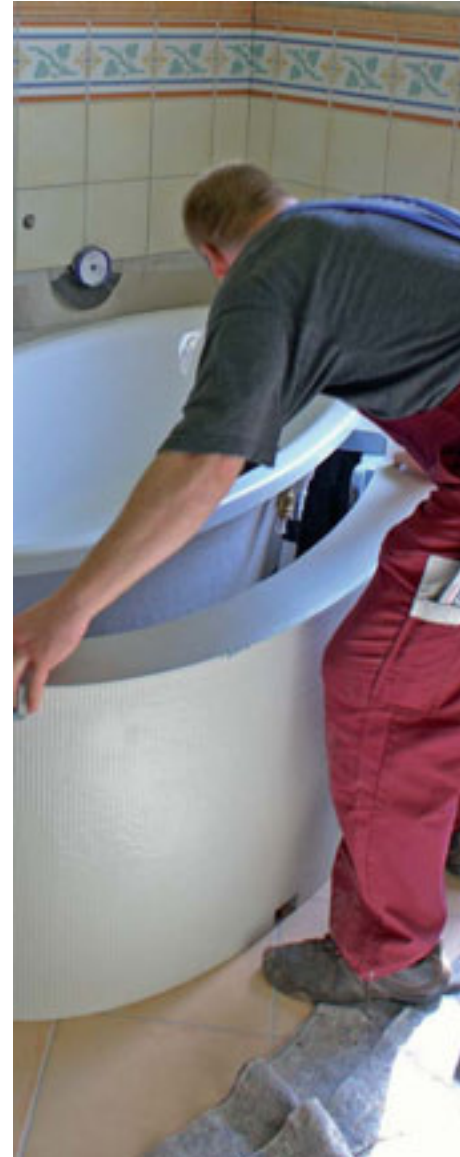

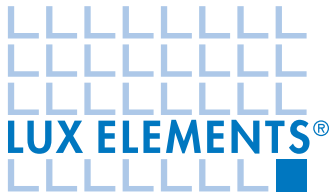

LUX ELEMENTS – The Construction

Designing with hard foam support elements

ELEMENT-VK

The multi-functional construction panel

Several functions in one product: ELEMENT-VK is a factory-sealed construction panel with vapour barrier properties, uniting all advantages of the universal construction panel ELEMENT-EL with those of a sealant.

ELEMENT-VK-panels are available in up to five thickness grades and two lengths. Due to its size, the shorter version can be transported and processed by a single person without help.

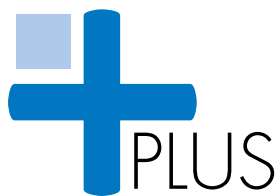

LUX ELEMENTS®-ELEMENT-PLUS

LUX ELEMENTS manufactures individual customised and special products for the ELEMENT product group. These include dimensions, thicknesses, shapes etc. that deviate from the standard program. For more information see page 35.





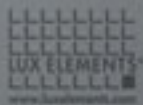
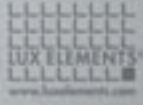

LUX ELEMENTS – The Construction

Designing with hard foam support elements

ELEMENT-VK

Multi-functional

1. Sealing layer – waterproof, vapour barrier
2. Contact mortar layer
3. Glass-fibre fabric
4. Contact mortar layer
5. Polystyrene hard-foam
6. Kontaktmörtelschicht
7. Glass-fibre fabric
8. Coating mortar layer

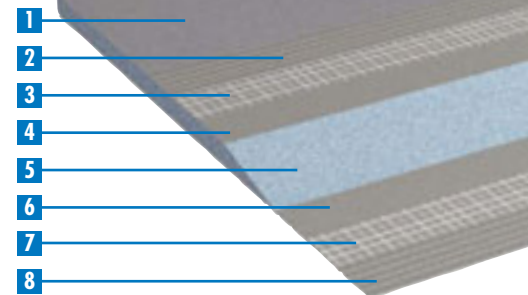

Test certificate no. P-AB/20802/06.4-2008 dated 19.02.2008 was issued for the product LUX ELEMENTS®-ELEMENT-VK by the Institute for textile building and environment technology (tBU).

Production of a sealing in combination with tile coverings and pavings using LUX ELEMENTS®-ELEMENT-VK as a sealing system acc. to Building Rules List A Part 2, no. 1.10 exposure class A1, A2, C

ELEMENT-VK is the optimal solution in damp rooms, in which a seal or a vapour barrier is required. Not only on the wall, on laths and stud frames, but also on the floor.

- ELEMENT-VK is **waterproof**
- The applied sealing membrane acts as a **vapour barrier**
- A general **appraisal certificate** ensures a tested system with coordinated system components
- Additional sealing is not required, thus saving time and costs.
- No dropping below the required **minimum coating thickness** (as, e.g., for liquid sealings)
- The fleece material is particularly **alkali-resistant** – providing high resistance in conjunction with cemented systems, hence ensuring a **long service life of the product**
- The ELEMENT-VK is **lightweight** (e.g. ELEMENT-VK Baby 12 under 3.5 kg) and therefore easy to process
- particularly resistant to **bending and pressure-stable**, therefore also suitable for floors

Working in a system

A range of matching system components is available for various application purposes (e.g. sealing tapes, inner and outer corners), harmonised to the multi-functional construction panel ELEMENT-VK.

Programme summary

LUX ELEMENTS®-ELEMENT



■ ELEMENT-EL

Hard foam support elements with mortar coating and glass fibre fabric on both sides.

Article-name	Dimensions width x length x thickness
ELEMENT-EL Baby 4	600 x 1250 x 4 mm
ELEMENT-EL Baby 6	600 x 1250 x 6 mm
ELEMENT-EL Baby 10	600 x 1250 x 10 mm
ELEMENT-EL Baby 12	600 x 1250 x 12 mm
ELEMENT-EL Baby 20	600 x 1250 x 20 mm
ELEMENT-EL Baby 30	600 x 1250 x 30 mm
ELEMENT-EL Baby 40	600 x 1250 x 40 mm
ELEMENT-EL Baby 50	600 x 1250 x 50 mm
ELEMENT-EL Baby 80	600 x 1250 x 80 mm
ELEMENT-EL Baby 100	600 x 1250 x 100 mm



Article-name	Dimensions width x length x thickness
ELEMENT-EL 10	600 x 2500 x 10 mm
ELEMENT-EL 12	600 x 2500 x 12 mm
ELEMENT-EL 20	600 x 2500 x 20 mm
ELEMENT-EL 30	600 x 2500 x 30 mm
ELEMENT-EL 40	600 x 2500 x 40 mm
ELEMENT-EL 50	600 x 2500 x 50 mm
ELEMENT-EL 80	600 x 2500 x 80 mm
ELEMENT-EL 100	600 x 2500 x 100 mm

■ ELEMENT-SL and ELEMENT-SQ

Pre-slit hard foam support elements with mortar coating and glass fibre fabric on both sides.



Article-name	Dimensions width x length x thickness
ELEMENT-SL 30, longitudinally slit	600 x 2500 x 30 mm
ELEMENT-SL 50, longitudinally slit	600 x 2500 x 50 mm
ELEMENT-SL 80, longitudinally slit	600 x 2500 x 80 mm
ELEMENT-SQ 30, transversely slit	600 x 2500 x 30 mm
ELEMENT-SQ 50, transversely slit	600 x 2500 x 50 mm
ELEMENT-SQ 80, transversely slit	600 x 2500 x 80 mm

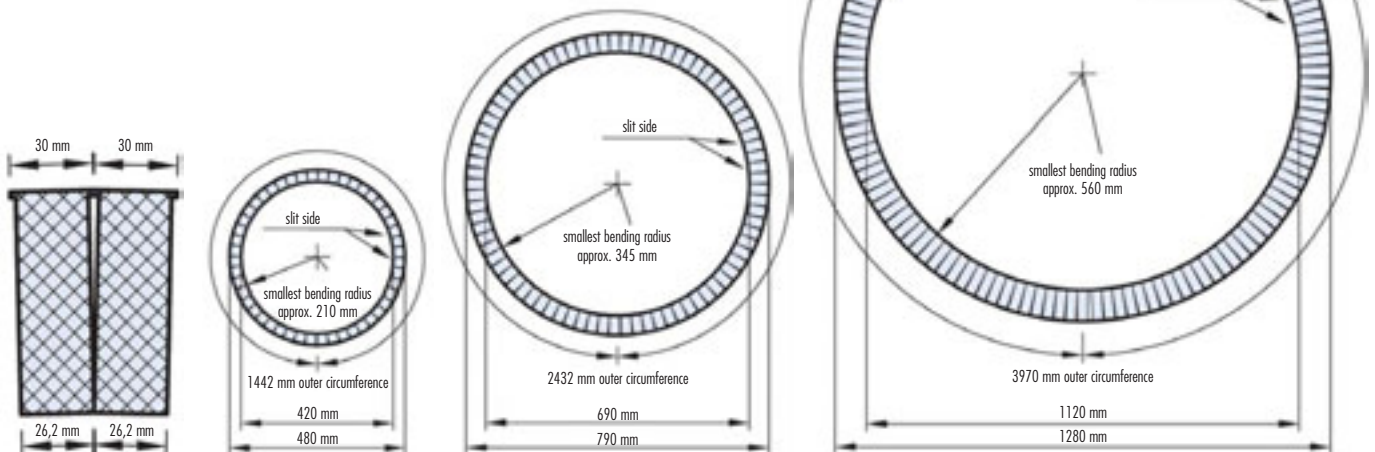



■ ELEMENT-VK

Hard foam support elements, fleece backed on one side, with mortar coating and glass fibre fabric on both sides.



■ System components

For fast and safe processing of the hard foam support elements, LUX ELEMENTS has suitable fastening sets and wall plugs, adhesives, sealing filler and sealing strips, reinforcement fabric and assembly aids (from page 60).

Article-name	Dimensions width x length x thickness
ELEMENT-VK Baby 6 , fleece backed on one side	600 x 1250 x 6 mm
ELEMENT-VK Baby 12 , fleece backed on one side	600 x 1250 x 12 mm
ELEMENT-VK Baby 20 , fleece backed on one side	600 x 1250 x 20 mm
ELEMENT-VK Baby 30 , fleece backed on one side	600 x 1250 x 30 mm
ELEMENT-VK Baby 50 , fleece backed on one side	600 x 1250 x 50 mm
ELEMENT-VK 12 , fleece backed on one side	600 x 2500 x 12 mm
ELEMENT-VK 20 , fleece backed on one side	600 x 2500 x 20 mm

■ Special formats – ELEMENT-PLUS

You can not find the right product? We also manufacture made-to-measure! Sizes, shapes, thicknesses etc., that do not correspond to the standard range can be enquired about separately at LUX ELEMENTS. After successful verification of the feasibility we will create a non binding offer. Once we receive your order, the order will be manufactured.



Note:

Technical details and accessories from page 56 onward.

For further information, please refer to our documents. Data sheets, test certificates and processing instructions can be downloaded from www.luxelements.com



LUX ELEMENTS – The Construction Designing with hard foam support elements

TEC

The installation claddings

TEC are prefabricated cladding elements made of polystyrene hard foam with mortar coating and glass fibre fabric on both sides. Suitable for vertical and horizontal claddings in corners or on straight surfaces.

TEC-SK are flat pipe cladding elements coated on both sides for angular shapes with groove and adhesive strip.

TEC-VWD are pre-fabricated elements for the cladding of wall-mounted system elements.

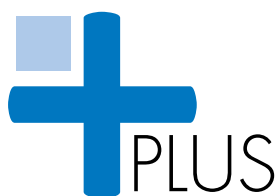

LUX ELEMENTS®-TEC-PLUS

LUX ELEMENTS manufactures individual customised and special products for the TEC product group. These include dimensions, thicknesses, shapes etc. that deviate from the standard program. For more information see page 41.

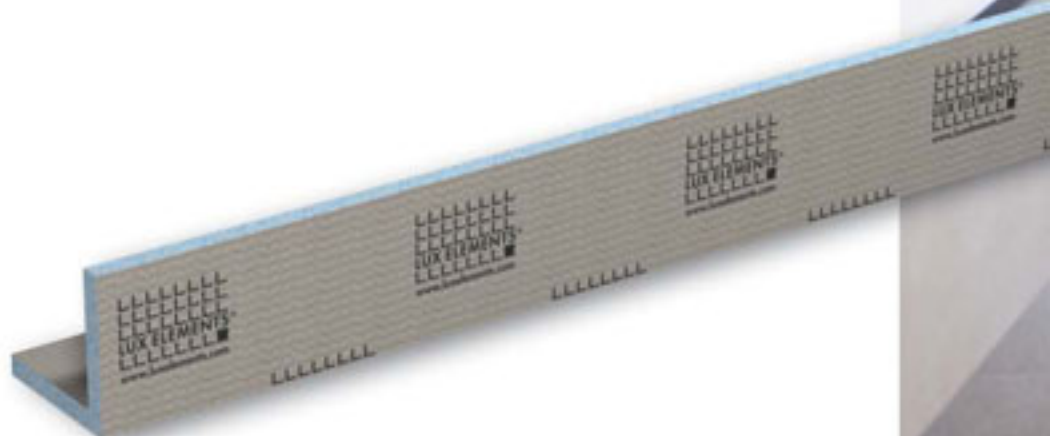

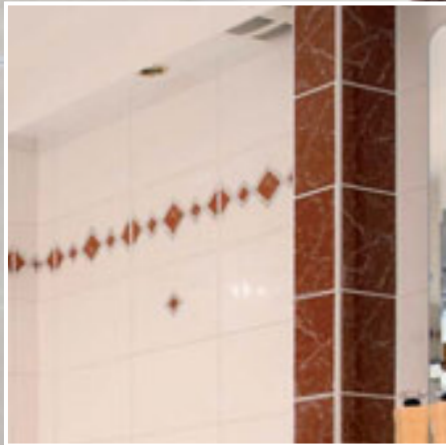

LUX ELEMENTS – The Construction

Designing with hard foam support elements

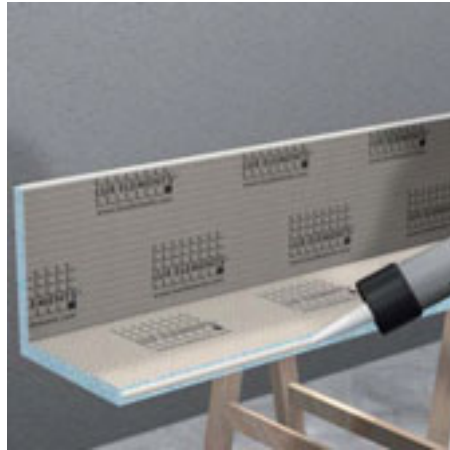

TEC-...

Pipe cladding elements

Square Elements

U-shaped

TEC-U are U-shaped rectangular cladding elements that are coated on both sides. These models are used for covering pipes on straight surfaces.

Angular

LUX ELEMENTS offers angular cladding elements that are coated on both sides for horizontal or vertical use in corners under the designation TEC-KA.

Elements for angular shape with groove and adhesive strip

The models TEC-SK, coated on both sides, are flat pipe cladding elements, which are only folded into an angular shape upon installation. For this purpose they are equipped with a groove and a corresponding adhesive strip.

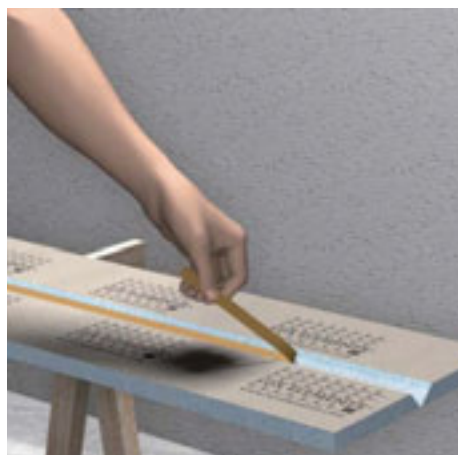
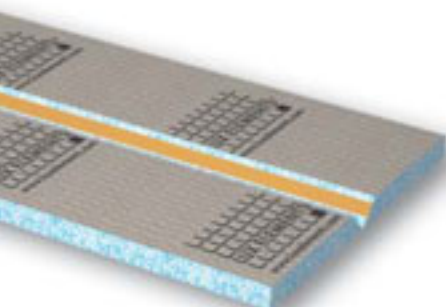
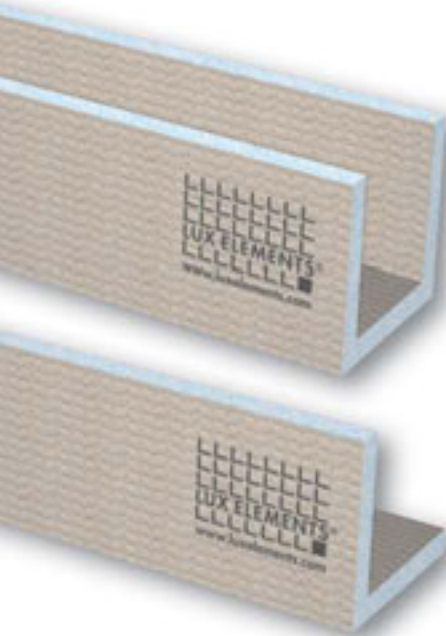

TEC-VWD

Cladding of wall-mounted constructions

TEC-VWD is a construction kit for the cladding of wall-mounted system elements.

The prefabricated, moisture-resistant elements made of hard foam support material can be individually adapted and can therefore be used for all conventional models.

Mounting set consisting of:

- 1 front panel with 5 boreholes
- 2 side panels
- 1 cover panel, adaptable on site
- incl. mounting accessories:
20 pieces FIX-SB 45S35, 10 m ARM-100 SK
and 1 cartridge COL-MK

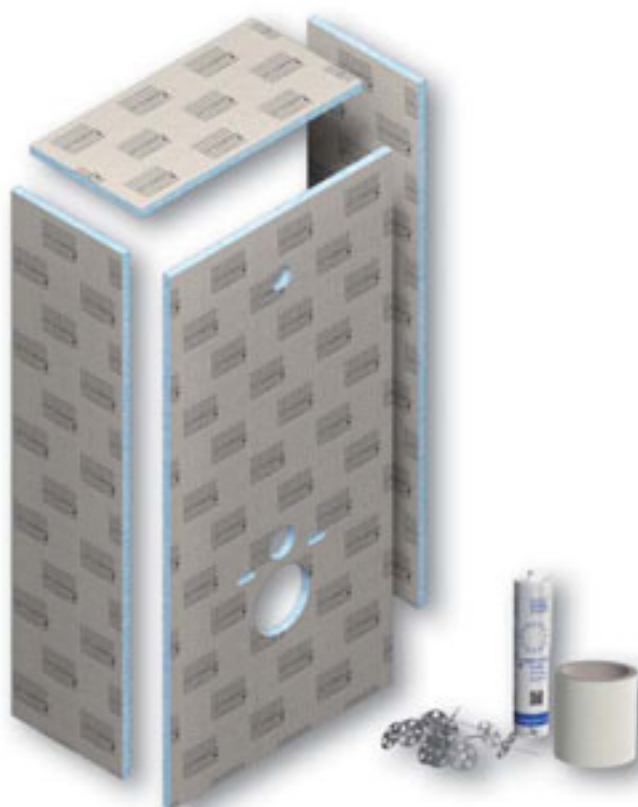

Note:

Technical details and accessories from page 56 onward.

For further information, please refer to our documents on www.luxelements.com



Programme summary

LUX ELEMENTS®-TEC

■ TEC-KA ... BS

Angular pipe cladding elements, coated on both sides, 2500 mm long, 20 mm thick.

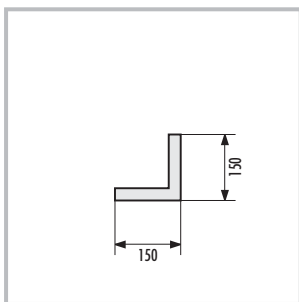

■ TEC-KA 15 BS

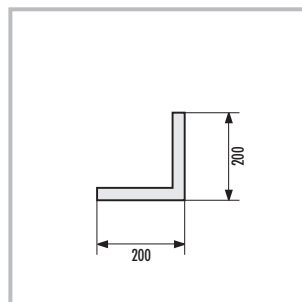

■ TEC-KA 20 BS

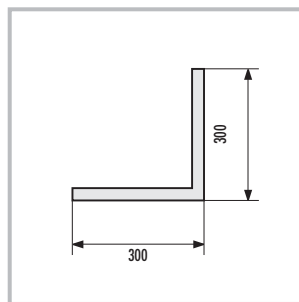

■ TEC-KA 30 BS

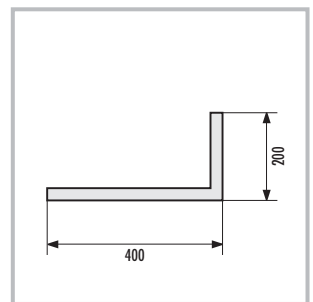

■ TEC-KA 40 BS

■ TEC-U ... BS

U-shaped pipe cladding element, straight, coated on both sides, 2500 mm long, 20 mm thick.

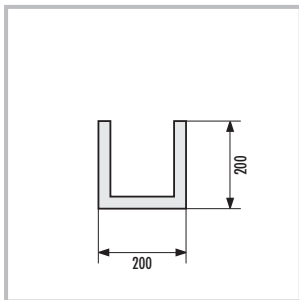

■ TEC-U 20 BS

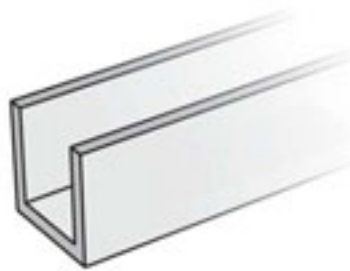

Dimensions in mm

■ TEC-SK ... BS

Pipe cladding element, coated on both sides, with adhesive groove for angular shape, 2500 mm long, 20 mm thick.

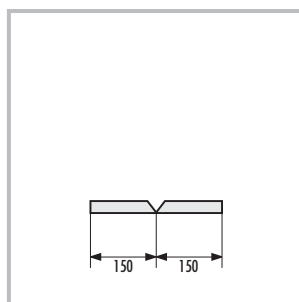

■ TEC-SK 15 BS, coated on both sides

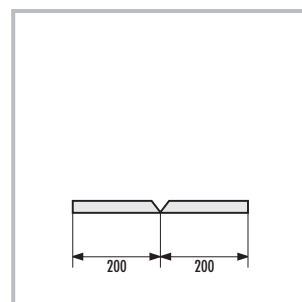

■ TEC-SK 20 BS, coated on both sides

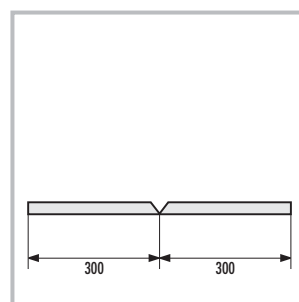

■ TEC-SK 30 BS, coated on both sides

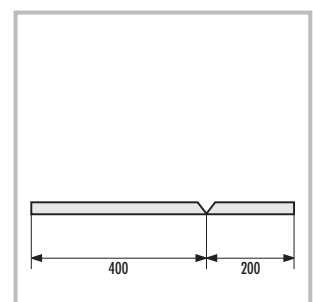

■ TEC-SK 40 BS, coated on both sides



■ TEC-VWD

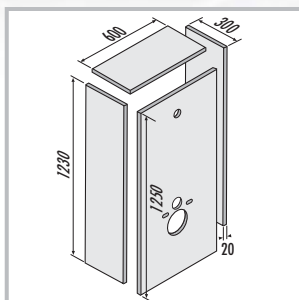

Prefabricated elements made of hard foam support material for cladding of wall-mounted constructions.

Mounting set consisting of:

1 front panel with 5 boreholes, 2 side panels, 1 cover panel, adaptable on site, incl. mounting accessories: 20 pieces FIX-SB 45S35, 10 m ARM-100 SK and 1 cartridge COL-MK

Dimensions in mm

■ System components



For fast and safe processing of the hard foam support elements, LUX ELEMENTS has suitable fastening sets and wall plugs, adhesives, sealing filler and sealing strips, reinforcement fabric and assembly aids (from page 60).

■ Special formats – TEC-PLUS

You can not find the right product? We also manufacture made-to-measure! Sizes, shapes, thicknesses etc., that do not correspond to the standard range can be enquired about separately at LUX ELEMENTS. After successful verification of the feasibility we will create a non binding offer. Once we receive your order, the order will be manufactured.



Note:

Technical details and accessories from page 56 onward.

For further information, please refer to our documents. Data sheets, test certificates and processing instructions can be downloaded from www.luxelements.com



LUX ELEMENTS – The Construction

Designing with hard foam support elements

TOP

Bath surrounds

TOP-TR... is a cladding for standard steel and plastic bath tubs. Ready for tiling, suitable for all installation situations. If a maintenance opening is required there are two solutions to choose from.

TOP-WP... is a completely removable cladding for whirlpools in four different sizes or made to measure.

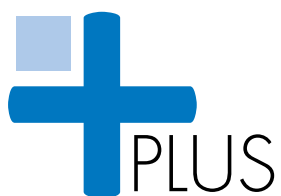

LUX ELEMENTS®-TOP-PLUS

LUX ELEMENTS manufactures individual customised and special products for the TOP product group. These include dimensions, thicknesses, shapes etc. that deviate from the standard program. For more information see page 49.







TOP-TR...

Bath tub surrounds

The design variants

Available are three different design variants for bath tub surrounds:

- Surrounds for smooth and flush bath cladding
- Surrounds with footboard
- Surrounds with ledge

The installation situations

For the three design variants the following installation positions are possible:

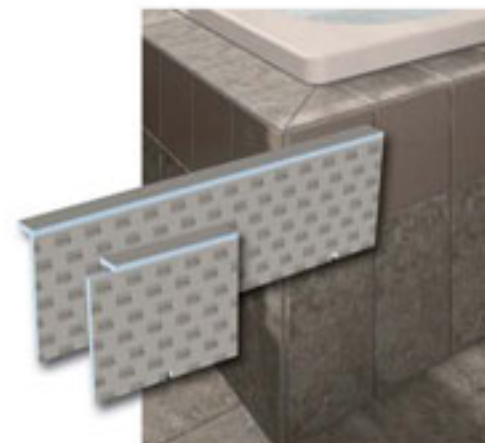
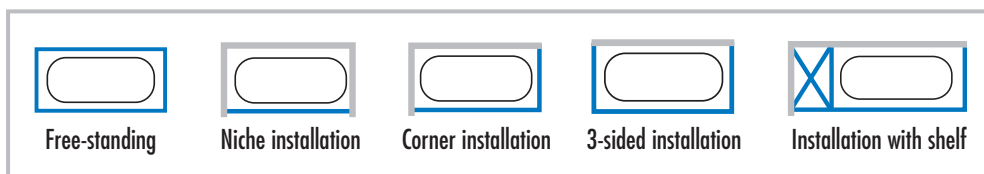

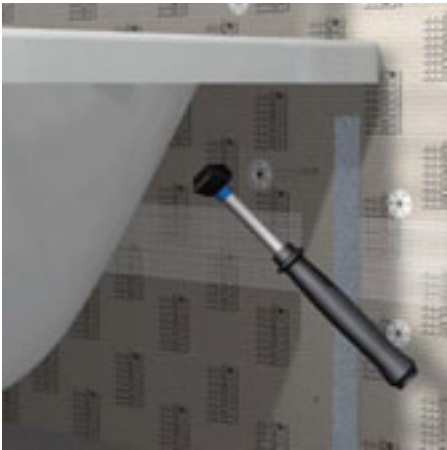

Inspection options

Two solutions are available to choose from for maintenance and repair for all TOP-TR... design variants

MONT-TOPREV – Easy, fast and flexible

After the bath cladding has been fitted, the gap for the maintenance opening is cut at the relevant place, to the appropriate size according to the joint pattern of the tiles. MONT-TOPREV holding profiles should be placed at the top and bottom and the sawn out part should be pressed into the opening against the holding profiles. The tiling should be completed and the joint around the cut out area should be sealed elastically using silicone. If the maintenance opening is used, the silicone should be cut off.

TOP-REVR – made-to-measure inspection opening

at the front or longitudinal side in any size, design variant:TRV. Forming a niche provides complete freedom of design and no dependence on the tile pattern. Fast opening and closing due to magnetic closure.

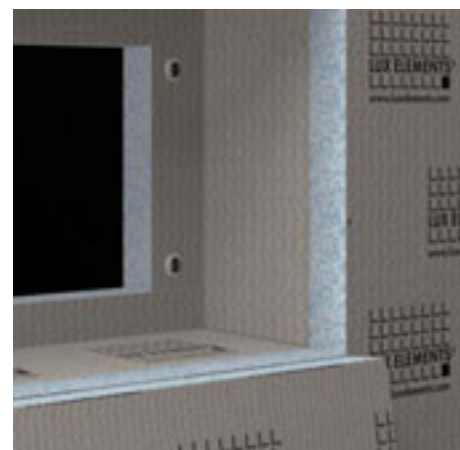
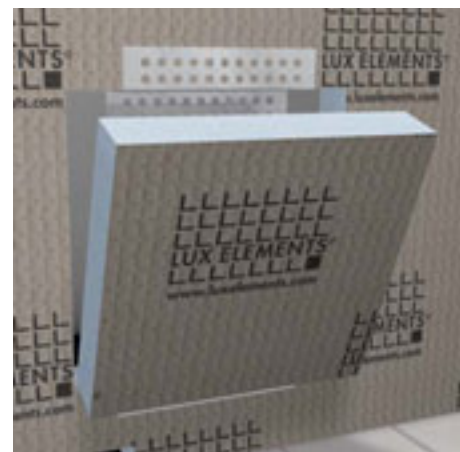



Note:

Technical details and accessories from page 56 onward.
For further information,
please refer to our documents
on www.luxelements.com



LUX ELEMENTS – The Construction

Designing with hard foam support elements

TOP-WP...

The removable whirlpool surround

The assembly of this whirlpool surround with footboard and ledge takes place using strong stainless steel metal fastening pipes, which are fitted into corresponding aluminum guide sleeves.

Therefore, entire front or side sections can be dismantled cleanly and without great effort. Available for rectangular, quadrant, hexagonal and oval shapes. In case of round shapes, strong magnets ensure additional hold.

The system

Example on a straight whirlpool bath tub (see pictures right):
First of all, mount the substructure, then hook on the cladding elements.
Assembly instructions see www.luxelements.com

Whirlpool shapes

All whirlpool surrounds are equipped with footboard and ledge.



Mounting aids

Mounting aids and complete assembly kits for bath tub surrounds and whirlpools with all necessary system components are available from LUX ELEMENTS (see page 49).

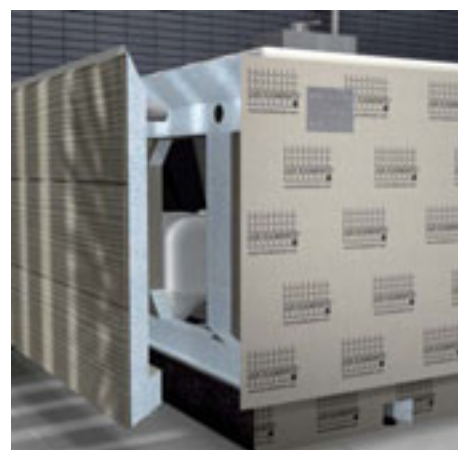
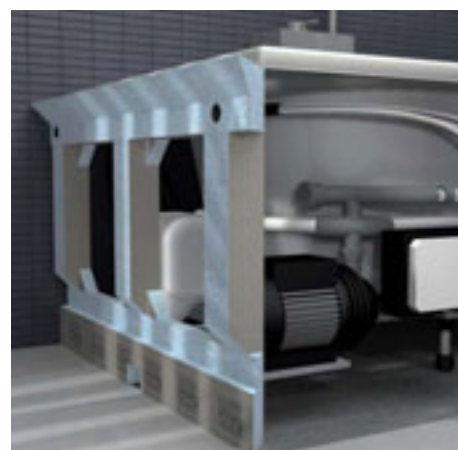

Programme summary

LUX ELEMENTS®-TOP

■ Bath tub surrounds

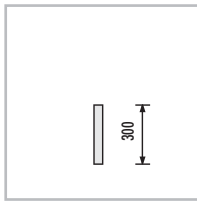
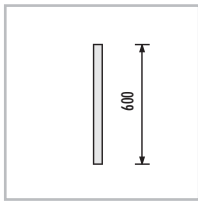
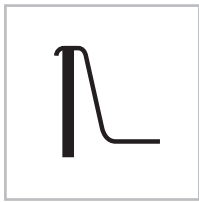

TOP-TRS – Surrounds for smooth and flush bath cladding, material thickness 30 mm.

Dimensions in mm



Article-name	Dimensions width x depth x height
TOP-TRS 1685 S, Surround for bath tubs up to 1700 mm	1685 x 600 x 30 mm
TOP-TRS 1785 S, Surround for bath tubs up to 1800 mm	1785 x 600 x 30 mm
TOP-TRS 1860 S, Surround for bath tubs up to 1900 m	1860 x 600 x 30 mm
TOP-TRS 2100 S, Surround for bath tubs up to 2100 mm or tubs with foot-end shelving	2100 x 600 x 30 mm
TOP-TRS 800 S, Surround for bath tub head end	800 x 600 x 30 mm
TOP-TRS 900 S, Surround for bath tub head end	900 x 600 x 30 mm
TOP-TRS 1200 S, Hard-foam cladding element for standard shower bases up to 1200 mm	1200 x 300 x 30 mm

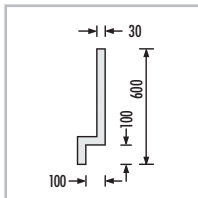
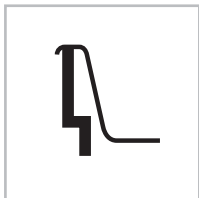

TOP-TRU – Surrounds with footboard, material thickness 30 mm.

Dimensions in mm



Article-name	Dimensions width x depth x height
TOP-TRU 2100 S, Surround with footboard for bath tubs up to 2100 mm or bath tubs with foot-end shelving	2100 x 600 x 30 mm
TOP-TRU 900 S, Surround with footboard for bath tub head end	900 x 600 x 30 mm

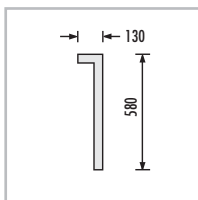
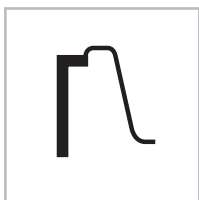

TOP-TRV – Surrounds with ledge, material thickness 30 mm.

Dimensions in mm

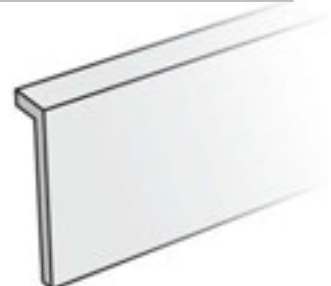

Article-name	Dimensions width x depth x height
TOP-TRV 2100 S, Surround with ledge for bath tubs up to 2100 mm	2100 x 600 x 30 mm
TOP-TRV 900 li S, Surround with ledge for left hand bath tub head end	900 x 600 x 30 mm
TOP-TRV 900 re S, Surround with ledge for right hand bath tub head end	900 x 600 x 30 mm

Please note: Bath tub surrounds for standard rectangular tubs are not available as kits. Depending on the installation situation as many as 4 elements are needed.



■ Whirlpool surrounds

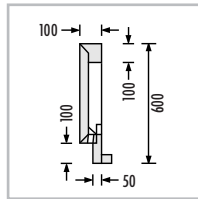
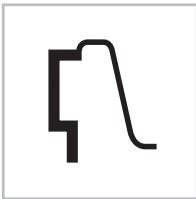

TOP-WP – removable whirlpool surround, with footboard and ledge. Material thickness 50 mm.

Dimensions in mm

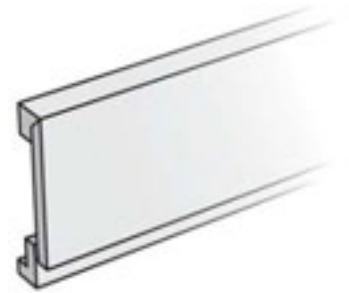

Article-name	Dimensions width x depth x height
TOP-WP G, Whirlpool surround (set) for straight and rectangular forms	made to measure
TOP-WP V, Whirlpool surround (set) for quadrant forms	made to measure
TOP-WP O, Whirlpool surround (set) for hexagonal forms	made to measure
TOP-WP S, Whirlpool surround (set) for oval forms	made to measure

■ Inspection options for TOP-TR...

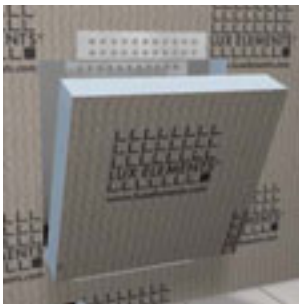

■ MONT-TOPREV

Mounting aid for maintenance openings for bath tubs consisting of 2 parts for top and bottom



■ TOP-REVR-TR,

Recessed, removable maintenance opening integrated into the front or side wall, for all TRV model design variants

■ Mounting aids



■ TOP-KIT

Mounting kit for bath tub surrounds:
4 pieces FIX-FID 110, 10 pieces FIX-SD 80,
1 piece COL-MK

■ TOP-KIT WP

Mounting kit for whirlpool surrounds:
10 pieces FIX-FID 110, 20 pieces FIX-SD 80,
1 piece COL-MK

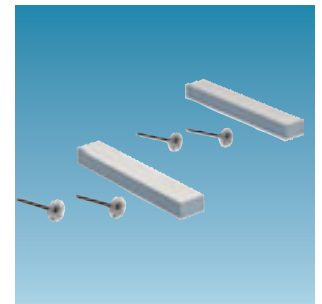

■ TOP-AN

Mounting aid for cladding elements: 2 rabbets EL 50 with 2 pieces FIX-FID 110 each

■ Special formats – TOP-PLUS

You can not find the right product? We also manufacture made-to-measure! Sizes, shapes, thicknesses etc., that do not correspond to the standard range can be enquired about separately at LUX ELEMENTS. After successful verification of the feasibility we will create a non binding offer. Once we receive your order, the order will be manufactured.



Note:

Technical details and accessories from page 56 onward.

For further information, please refer to our documents. Data sheets, test certificates and processing instructions can be downloaded from www.luxelements.com



LUX ELEMENTS – The Construction Designing with hard foam support elements

LAVADO

The washstands

In this product group, washstands are offered in several versions for individual tiling under the designation LAVADO-FLOAT. The special trick is the invisible suspension in the wall, which makes the washstands appear to “float”. The assembly height is flexible.

Three models have a trough in different shapes. The fourth model is even and therefore suitable for conventional top-mounted or fitted wash basins.

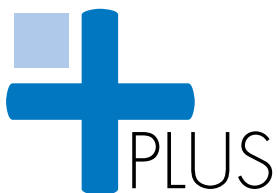

LUX ELEMENTS®-LAVADO-PLUS

LUX ELEMENTS manufactures individual customised and special products for the ELEMENT product group. These include dimensions, thicknesses, shapes etc. that deviate from the standard program. For more information see page 54.

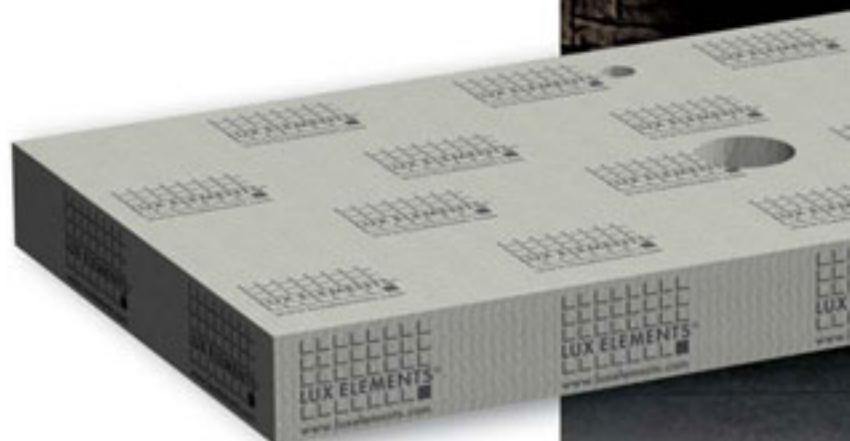

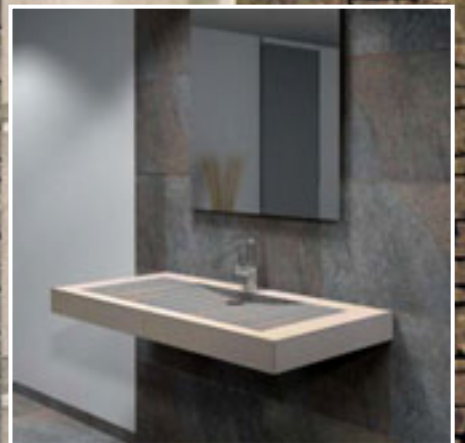
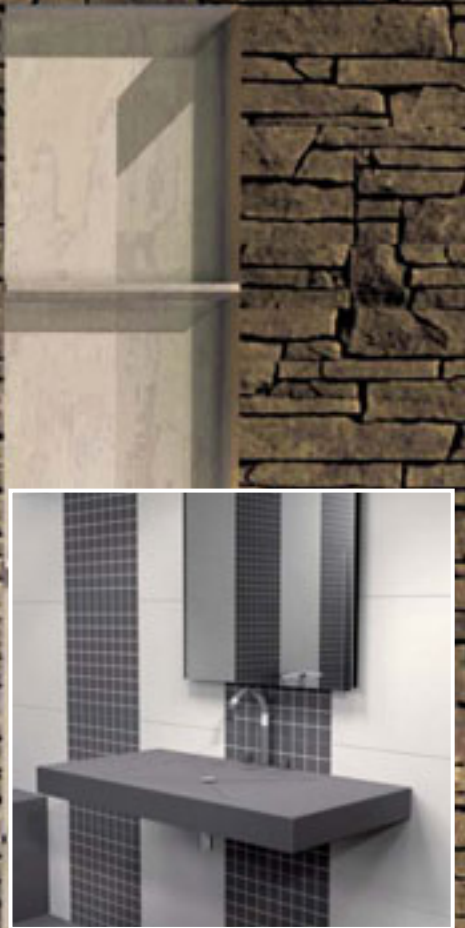



LUX ELEMENTS – The Construction

Designing with hard foam support elements



LAVADO

Washstands in “floating design”

LAVADO-FLOAT

LAVADO-FLOAT are washstand models made of hard foam support material for individual tiling. An invisible suspension provides the four model variants with or without recess with a “floating design”.

The installation of LAVADO-FLOAT is possible not only on masonry but also on stud frames – quickly, easily and reliably. Two stainless steel brackets ensure stable suspension.

Conventional stem valves e.g. Viega Visign V1 are suitable for the drain connection.

The washstands can be shortened at the sides, which enables them to be adapted to smaller bathrooms. The construction of a row of washstands is also possible by means of arranging and gluing together several washstands.



Benefits at a glance:

■ Individual design

Surface design freely selectable

■ Easy to process

Prefabricated, ready for tiling

■ Modern bathroom design with a “floating” look

Sturdy, invisible suspension

■ For every room situation

Flexible width from 620 to 1170 mm, simple to shorten

■ Good combinability

Double washstands and row constructions are easy to implement

■ More space thanks to self-supporting construction

Ideally for barrier-free bathrooms

Programme summary

LUX ELEMENTS®-LAVADO

■ LAVADO-FLOAT

Washstands with invisible suspension as set for single washing facility, incl. 1 piece COL-MK and 2 stainless steel brackets 550 mm in length.

LAVADO-FLOAT G

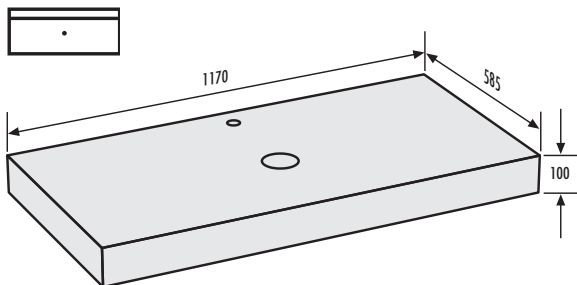

■ LAVADO-FLOAT G, washstand, even, without recess

LAVADO-FLOAT Z

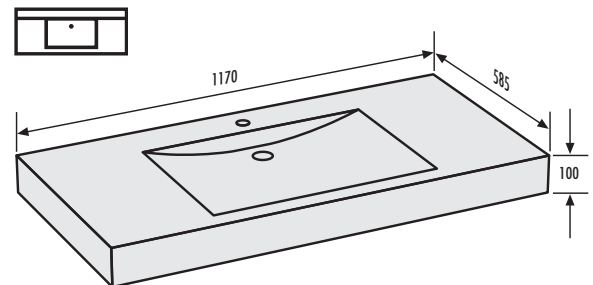

■ LAVADO-FLOAT Z, washstand with cylindrical recess

LAVADO-FLOAT E

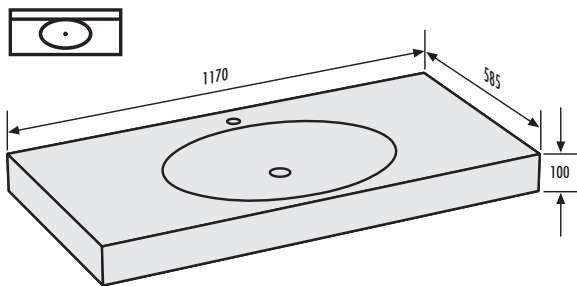

■ LAVADO-FLOAT E, washstand with elliptical recess

LAVADO-FLOAT R

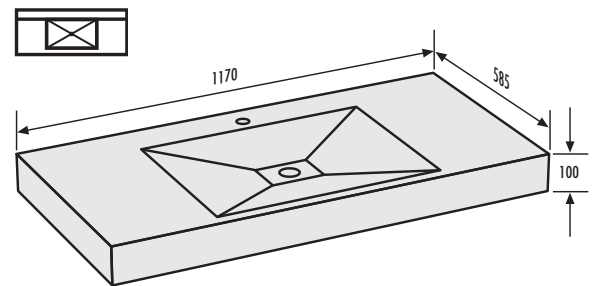

■ LAVADO-FLOAT R, washstand with rectangular recess

Dimensions in mm

■ Special formats – LAVADO-PLUS

You can not find the right product? We also manufacture made-to-measure! Sizes, shapes, thicknesses etc., that do not correspond to the standard range can be enquired about separately at LUX ELEMENTS. After successful verification of the feasibility we will create a non binding offer. Once we receive your order, the order will be manufactured.



■ System components

For fast and safe processing of the hard foam support elements, LUX ELEMENTS has suitable fastening sets and wall plugs, adhesives, sealing filler and sealing strips, reinforcement fabric and assembly aids (from page 60).



Note:

Technical details and accessories from page 56 onward.

For further information, please refer to our documents on www.luxelements.com



Processing and design

Techniques and accessories

The hard foam support elements from LUX ELEMENTS are easy to use. Not only the cutting of the lightweight material, but also the reinforcement, adhesion or fixation. The right technique is important, with the suitable tools and system components!

- Each well-stocked tool kit contains tools for cutting, filling, fixing, measuring and aligning. Starting with a pencil, over a level through to a jigsaw.
- You can obtain the products required for safe processing from us!
 All components are tested as a system with the hard foam support elements.

On the following pages you will find an overview of tools and system components in conjunction with the most important application steps. The LUX ELEMENTS technical department is available for any further questions you might have.





Processing and design

The most important tools

The hard foam support elements from LUX ELEMENTS are easy to process. Suitable for the processing are standard tools found in any toolbox.



■ Cuts and notches

- Jig saw, serrated saw blade (e.g. type Bosch T313AW HCS) suitable for EL 4 to EL 100
- Angle grinder with diamond wheel suitable for EL 4 to EL 50
- Cutter suitable for EL 4 to EL 20
- Circular table saw



■ Application of filler, for plastering and smoothing

- Bricklayer's trowel
- Smoothing trowel
- Notched trowel



■ Fixing and mounting

For general work involved in mounting dowels, hammer fix plugs, screws, you need:

- Drill
- Cordless screwdriver
- Hammer



■ Measuring, marking, aligning and checking

- Spirit Level
- Folding ruler
- Pencil
- Cross slot screwdriver
- Level for checking even surfaces



■ Other important accessories are:

- Cartridge gun for pressing out glue cartridges
- Emery board for grinding uncoated edges of the ELEMENT construction panels
- Broad brush



NOTE:

For further information, please refer to our documents. Data sheets, test certificates and processing instructions can be downloaded from www.luxelements.com

Processing

Cutting – techniques

■ Cutting with the cutter – suitable for material thickness 4 to 20 mm



1a Carry out a continuous cut on the top side of the hard foam support element along an applied ruler using the cutter.

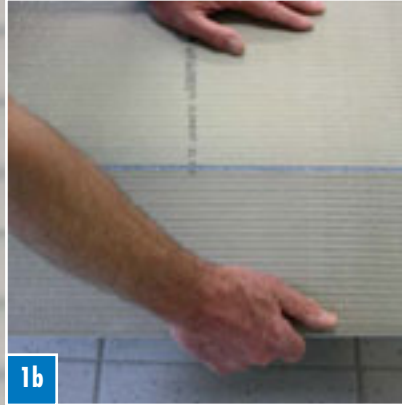

1b A single cut is sufficient to split thinner panels (4 mm). For thicker panels from 6 mm to 20 mm, bend along the cut.



1c Then use the cutter to sever the mortar layer and the glassfibre fabric on the rear side of the hard foam support element in its bent state.

■ Cutting with the angle grinder (flex) – suitable for material thickness 4 to 50 mm



2a Before cutting, draw a cutting line using a pencil and a ruler.



2b Apply the angle grinder (segmented diamond grindingsheet) and cut through along the cutting line (very easy cutting).



2c A smooth, clean cutting edge is created.

■ Cutting with the jig saw – suitable for material thickness 4 to 100 mm

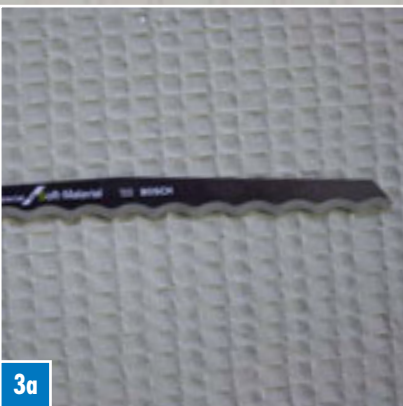

3a For a clean cut, we recommend a jig saw with a serrated blade (e.g. type Bosch T313AW HCS).



3b Before the actual cut, draw a cutting line using a pencil and a ruler. Then cut to size along the line using the jig saw (very easy cut).

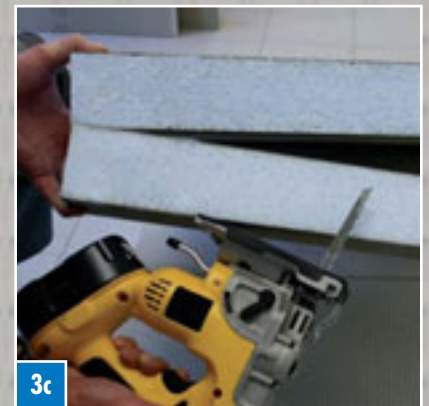

3c Thick panels up to 100 mm can be cleanly cut using this technique. The jig saw is also particularly suitable for cutting contours and curves.

Processing

Adhesion – techniques

■ Full-surface adhesion – with notched or smoothing trowel

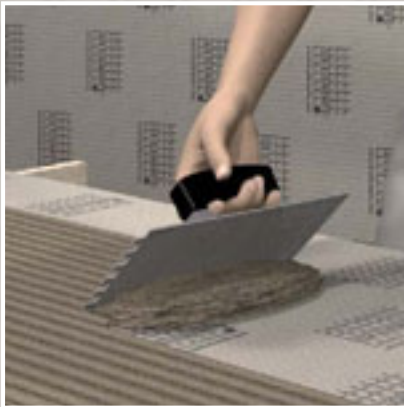

Full-surface application of fixing adhesive with the notched trowel for wall and floor applications.



The application of fixing adhesive with a smoothing trowel is recommended e.g. as a contact layer.



Tile laying using the thin-bed method. Apply tile adhesive over the full surface using a notched trowel.

■ Pointwise adhesion – by means of dots (ELEMENT-EL ≥ 6 mm)

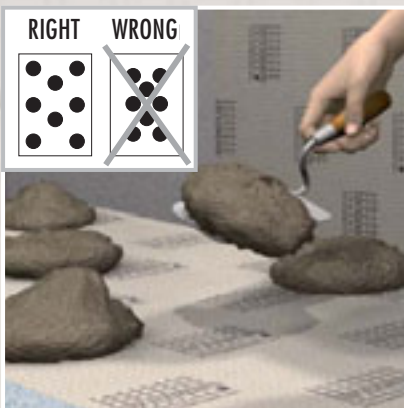

For height compensation in case of uneven substrates, apply the fixing adhesive pointwise using dots of adhesive (8–10 dots per m²).

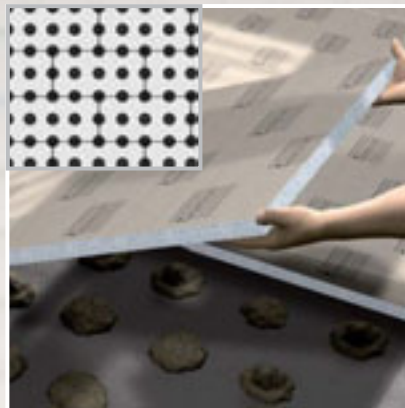

Floor application: dot spacing (25–36 dots per m²) approx. 20 cm. Place panels in bond onto the adhesive and press on (cross joints not allowed!).

■ Edge adhesion

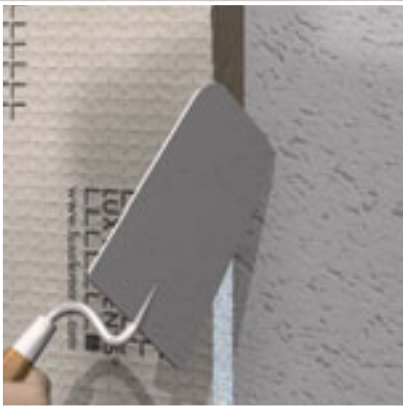

To bond the edges, e.g. for joints, apply the fixing adhesive with a bricklayer's trowel.



When applying mounting adhesive, snake-shaped application is recommended, not only for hard foam support elements...



...but also for metal, wood, wooden materials, stone, ceramics and plastic.

LUX ELEMENTS®-System components

COL – Adhesives

LUX ELEMENTS®-COL are adhesives and primers for attaching, laying, bonding, gluing and mounting of LUX ELEMENTS® hard foam support elements:



■ LUX ELEMENTS®-COL-AK – Fixing adhesive

A ready-mixed dry mortar for the attaching and adhesion of LUX ELEMENTS® hard foam support elements. COL-AK is: stable, fast bonding, frost-proof, waterproof.



■ LUX ELEMENTS®-COL-FLEX – Bonding mortar

COL-FLEX is a flexible cement powder adhesive and is used in particular for laying onto LUX ELEMENTS® hard foam support elements, alternative seals (DRY-ASK) or substrates where stresses are a possibility.



■ LUX ELEMENTS®-COL-MK – Mounting adhesive

COL-MK is a moisture-curing, 1-component adhesive on an STP polymer basis for the gluing of LUX ELEMENTS® hard foam support elements. Furthermore, COL-MK adheres to various substrates such as metals, wood materials, ceramics, glass and other building materials.



■ LUX ELEMENTS®-COL-HSV Primer

Solvent-free dispersion primer, primarily suitable for wooden substrates and for pretreatment of highly absorbent substrates.



LUX ELEMENTS – The Construction

Designing with hard foam support elements

Processing

Reinforcing – techniques

■ Reinforcement of panel joints, transitions, corners and surfaces

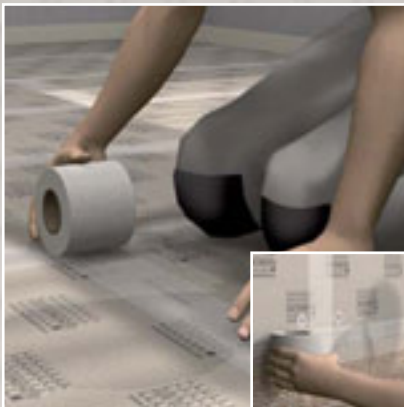

All element joints on the wall and floor must be reinforced with self-adhesive, narrow reinforcement strips.



Slightly broader, self-adhesive reinforcement strips are used for the reinforcement of corners.



A particularly broad reinforcement fabric that is embedded on the surface and then levelled out with fixing adhesive is suitable for use on floors and larger surfaces.

LUX ELEMENTS®-System components

ARM – Reinforcement fabric

LUX ELEMENTS®-ARM are reinforcement fabrics for board joints, transitions, surfaces and corners in various widths.



■ LUX ELEMENTS®-ARM-100 SK
Reinforcement fabrics for transitions and board joints
self-adhesive, 100 mm broad



■ LUX ELEMENTS®-ARM-150 SK
Reinforcement fabrics for corners
self-adhesive, 150 mm broad



■ LUX ELEMENTS®-ARM-250 SK
Reinforcement fabrics for corners
self-adhesive, 250 mm broad



■ LUX ELEMENTS®-ARM-600
Reinforcement fabrics for surfaces
600 mm broad



Processing

Mounting – techniques

■ Bonding of hard foam support elements to one another or on walls and floors



Mounting aid for the bonding of hard foam support elements to one another e.g. for the extension of walls.

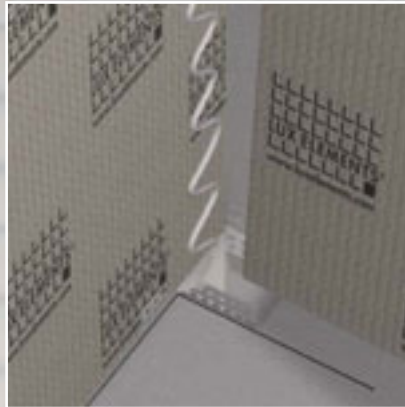

Mounting aids in various shapes facilitate the installation of hard foam support elements on the floor, even for installation around corners.



Special mounting profiles facilitate the insertion of maintenance openings for whirlpools and bath tubs.

LUX ELEMENTS®-System components

MONT – Mounting aids

LUX ELEMENTS®-MONT-H, -UNI, -T and -E for screwing or for using adhesive help in connecting LUX ELEMENTS® hard foam support elements one to another or to walls and floors.



■ LUX ELEMENTS®-MONT-H
Mounting aid for material thickness 50/80 mm, connecting hard foam support elements

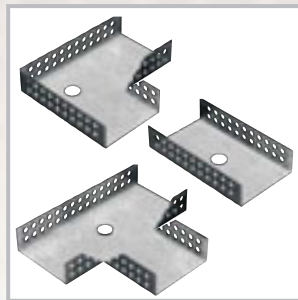

■ LUX ELEMENTS®-MONT-UNI/-T/-E
Mounting aid for material thickness 50/80 mm, wall and floor connection, U-shape or for T-and corner-connection.

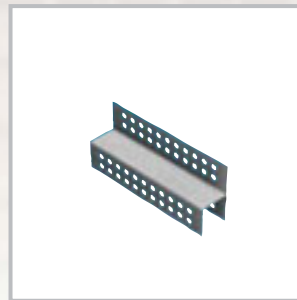

■ LUX ELEMENTS®-MONT-TOPREV
Mounting aid for maintenance openings for both tubs consisting of 2 parts for top and bottom

LUX ELEMENTS – The Construction

Designing with hard foam support elements

Processing

Fixing – techniques

■ Fixing with plastic or metal hammer fix plugs

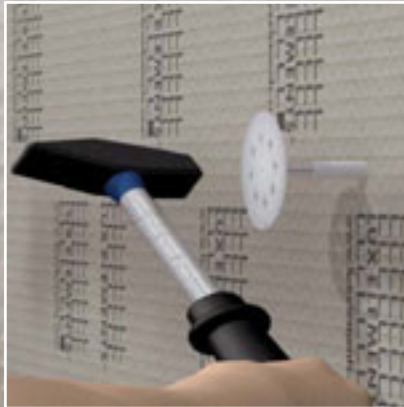

Plastic hammer fix plugs serve for the connection of hard foam support elements to walls in damp and wet areas.

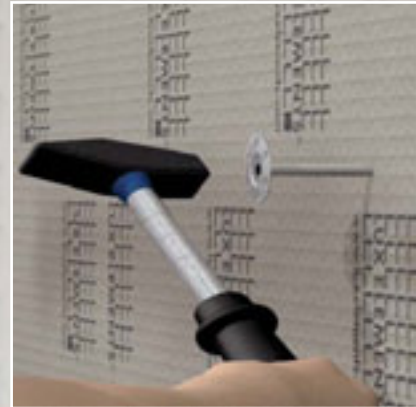

Metal hammer fix plugs are suitable for longer anchorage depths in wall mounting.



■ Fixing with screw plugs

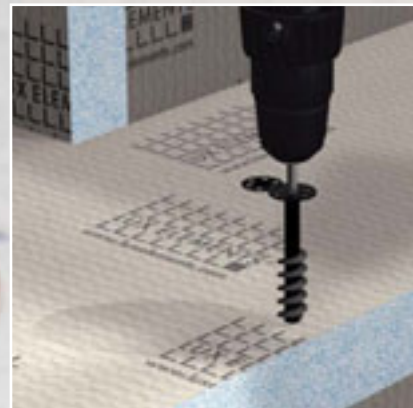

Plastic screw plugs enable the connection of hard foam support elements to one another.

NOTE:
 For further information,
 please refer to our documents.
 Data sheets, test certificates
 and processing instructions
 can be downloaded from
www.luxelements.com



■ Fixing with screw and washer – for assembly on wood or stud frames



Hard foam support elements are screwed to wooden floors using suitable screws and corresponding washers.



Fastening sets with screws and washers are suitable for the assembly of hard foam support elements on stud frames.

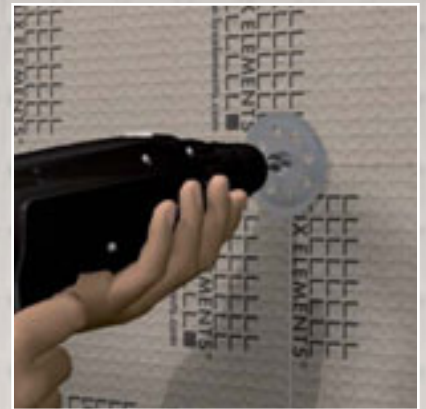

Different fastening sets are used depending on the type of stud frame – wood or metal.

LUX ELEMENTS®-System components

FIX – Fastening sets and dowels

LUX ELEMENTS®-FIX are fastening sets/aids and dowels for LUX ELEMENTS® hard foam support elements.

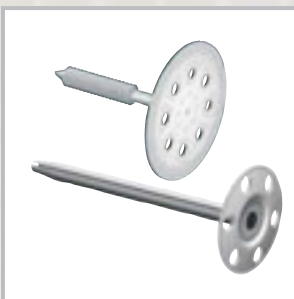

■ **LUX ELEMENTS®-FIX-KSD**
Plastic hammer fixing plug
for fixing hard foam support elements to an interior wall.

■ **LUX ELEMENTS®-FIX-FID**
Hammer fix plug

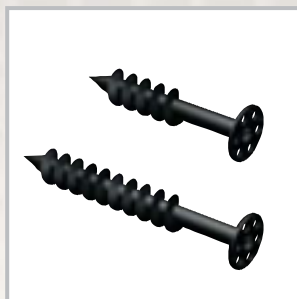

■ **LUX ELEMENTS®-FIX-SD**
Special screw plug
for connecting hard foam support elements.

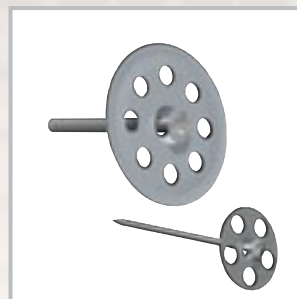

■ **LUX ELEMENTS®-FIX-HS 80S70**
Screw with washer
for wooden substrate

■ **LUX ELEMENTS®-FIX-SB**
Screw and washer fastening set
for the installation on supports.

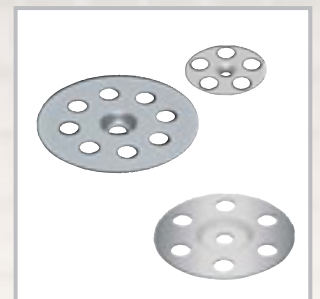

■ **LUX ELEMENTS®-FIX-S**
Washer
galvanised or stainless steel



LUX ELEMENTS – The Construction

Designing with hard foam support elements

Processing

Sealing – techniques

■ Liquid sealing



Liquid sealing compounds applied with a smoothing trowel are recommended for sealing hard foam support elements.

■ Web-type sealing

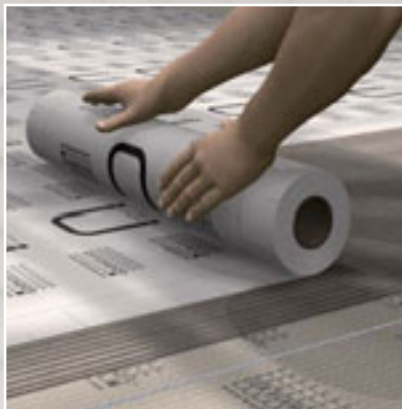

A common method of surface sealing on floors or walls is the embedding of a thin, tear resistant special fleece.



LUX ELEMENTS®-System components

DRY – Sealing filler and sealing tapes



■ **LUX ELEMENTS®-DRY-ASK**
Filling wall and floor surfaces
Single-component, water-impermeable, crack-bridging and flexible sealing compound and is particularly suitable for sealing LUX ELEMENTS® hard foam support elements.



■ **LUX ELEMENTS®-DRY-DB**
Integrating sealing tape into wall/floor connections
Extremely thin, tear-resistant special fleece for sealing. Suitable for all connection seals occurring in conjunction with DRY-ASK or DRY-DF.

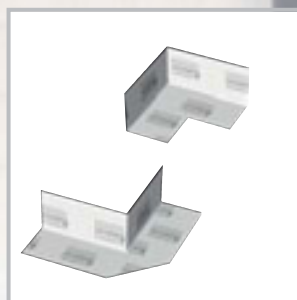

■ **LUX ELEMENTS®-DRY-DBIE**
Forming inner corners
■ **LUX ELEMENTS®-DRY-DBAE**
Forming outer corners

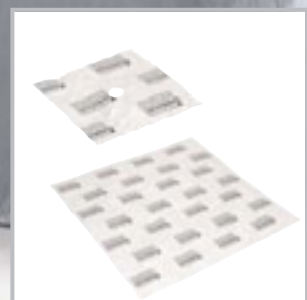

■ **LUX ELEMENTS®-DRY-DBWM**
Sealing pipe ducts
Wall sleeves for the sealing of pipe ducts.
■ **LUX ELEMENTS®-DRY-DBBM**
Sealing floor drains
Floor sleeves for the sealing of floor drains.

■ Sealing with sealing tapes, sleeves and shaped parts

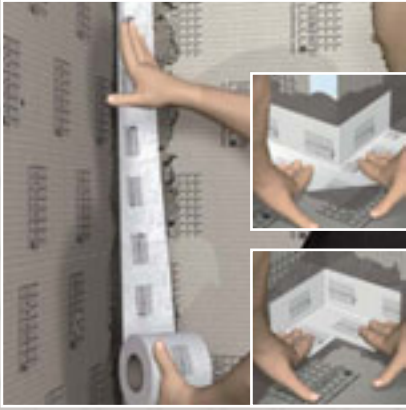

Transitions on walls and floors can be sealed using sealing tapes as well as shaped parts for inner and outer corners.

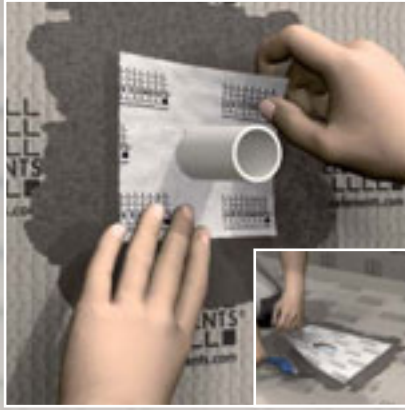

The reliable sealing of pipe penetrations takes place using shaped parts having a prefabricated hole for the pipe.

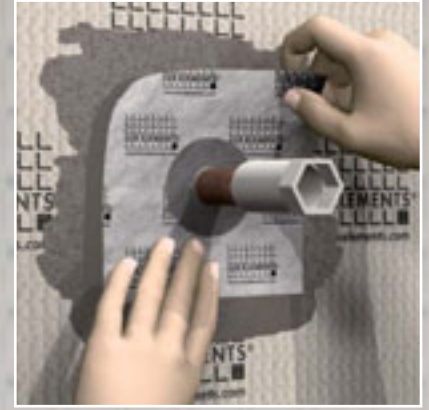

Sealing sleeves with expansion zones in the middle are the ideal solution for sealing pipe penetrations in permanently installed construction stoppers.

■ Sealing in the system – with the sealed construction panel ELEMENT-VK

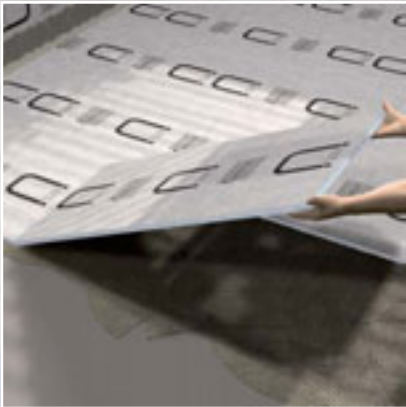

System components with the same characteristics are required for the factory-sealed, vapour-barring construction panel ELEMENT-VK.

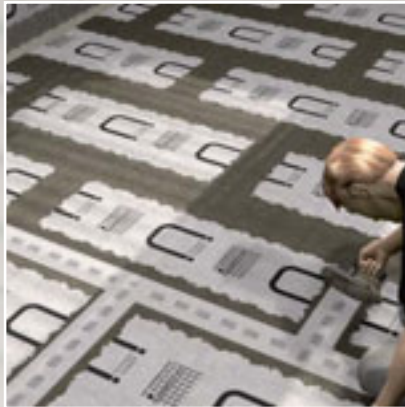

Sealing of the joints is performed using corresponding sealing tape and a suitable tape sealer.

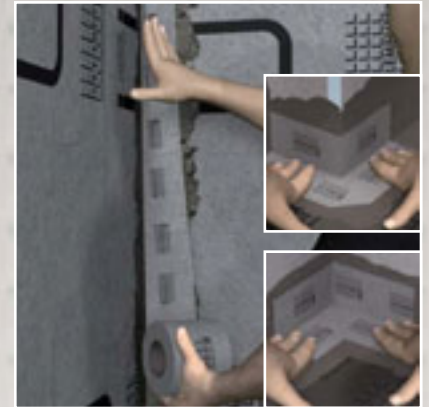

Corner transitions are reliably sealed with vapour-barring sealing tape and the corresponding shaped parts.

LUX ELEMENTS®-DRY are sealing tapes, films and fillers suitable for sealing purposes.

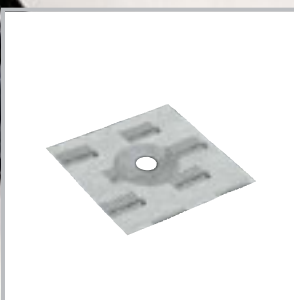

■ LUX ELEMENTS®-DRY-DBDZM –

Expansion zone sleeve

On PU basis. Two different sizes having a central expansion zone to enable pipes of different external diameters to be sealed. Installation in combination with DRY-ASK.



■ LUX ELEMENTS®-DRY-DF

Sealing film for surfaces

Extremely thin, tear-resistant special tissue for sealing and suitable for laminar, alternative seals on floors and walls. The DRY-DB and DRY-ASK system components complete the sealing at transitions, corner etc.

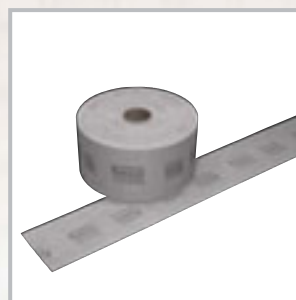

■ LUX ELEMENTS®-DRY-DBV

Sealing tape

with sealing vapour-barrier properties for use on the fleece-backed ELEMENT-VK, e.g. for sealing plate joints.

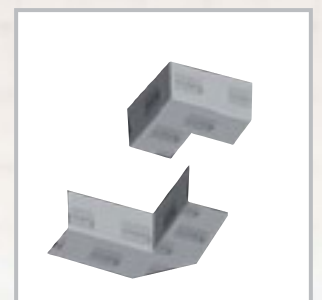

■ LUX ELEMENTS®-DRY-DBVIE

Forming inner corners

with additional vapour-retardant properties.

■ LUX ELEMENTS®-DRY-DBVAE

Forming outer corners

with additional vapour-retardant properties.

Processing

Sealing – Connection to a shower area

All from one source: LUX ELEMENTS offers all components for the entire shower area: starting from the construction panel for wall and floor installation over the shower base through to all required sealing materials for the transitions. All in all, this results in a perfectly coordinated and tested system.

The advantages for the installer are:

- High degree of safety
- Construction and sealing in one

NOTE:
 Please also observe the approvals for our products in accordance with the national directives. These are constantly being extended.

You can view the current status of all documents applicable for your country under "Downloads" at www.luxelements.com or simply contact us.

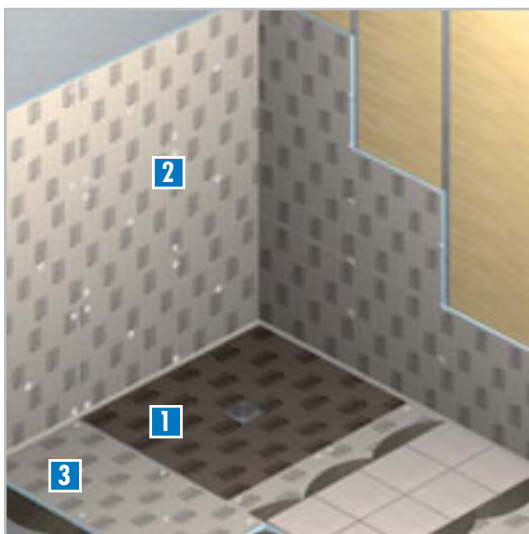

General design of a shower area using LUX ELEMENTS®-ELEMENT-EL:

- 1 TUB – Floor structure with shower base flush with the floor, factory sealing
- 2 ELEMENT-EL – wall structure on masonry, concrete or plaster, wooden or metal stud frame or free-standing with waterproof construction panel
- 3 ELEMENT-EL – Floor structure on wooden floor or mineral substrate

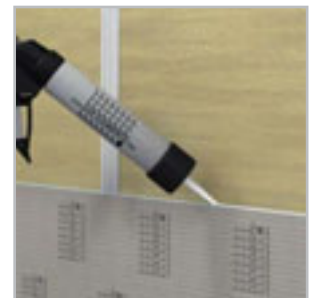

In non-public areas it is possible to create a bond using LUX ELEMENTS®-COL-MK mounting adhesive for wall installation, which simultaneously serves as a sealing.

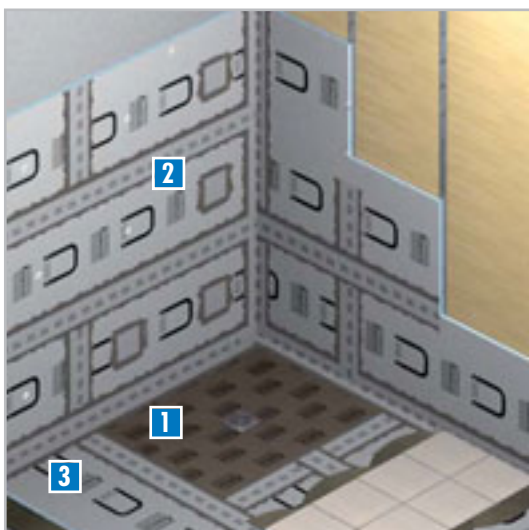

General design of a shower area using LUX ELEMENTS®-ELEMENT-VK:

- 1 TUB – Floor structure with shower base flush with the floor, factory sealing
- 2 ELEMENT-VK – Wall structure on masonry, concrete or plaster, wooden or metal stud frame or free-standing with plate-type composite sealing
- 3 ELEMENT-VK – Floor structure on wooden floor or mineral substrate

Further requirements regarding sealing elements must be taken into consideration in accordance with national directives (see also: types of seals p..65).

Today we differentiate between three different types of composite sealing:

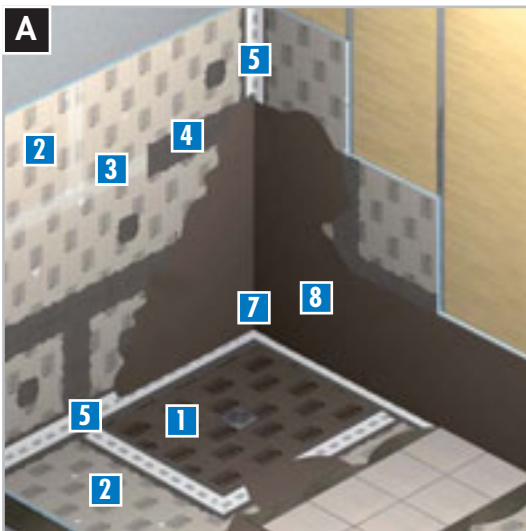

Liquid sealings

for use with the following products:

- 1 TUB – flush with the floor shower base
- 2 ELEMENT-EL – waterproof construction panel
- 3 ARM-100 SK – reinforcing fabric for joints
- 4 COL-AK – fixing adhesive for levelling out the reinforced joints
- 5 DRY-DB – sealing tape for transitions
- 6 DRY-ASK – sealing filler for sealing in the sealing tapes
- 7 DRY-DBIE – sealing tape as a shaped part “inner corner”
- 8 DRY-ASK – sealing filler, full-surface

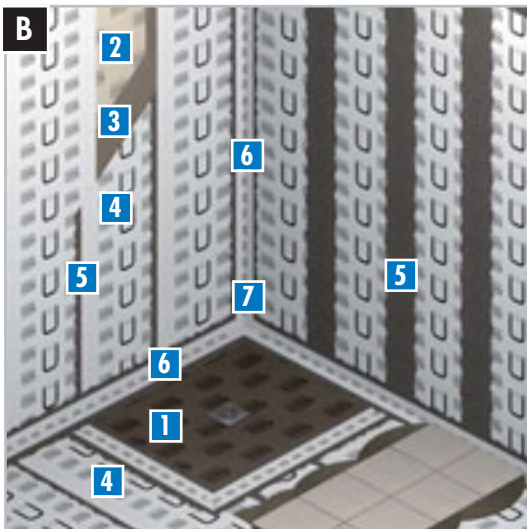

Web-type sealings

for use with the following products:

- 1 TUB – flush with the floor shower base
- 2 ELEMENT-EL – waterproof construction panel
- 3 COL-FLEX – mineral adhesive for the bonding of sealing film
- 4 DRY-DF – sealing film
- 5 DRY-ASK – sealing filler for bonding and sealing in the sealing film and sealing tapes
- 6 DRY-DB – sealing tape for transitions
- 7 DRY-DBIE – sealing tape as a shaped part “inner corner”

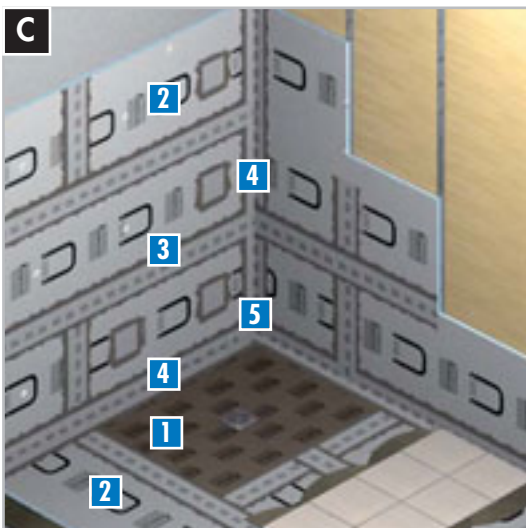

Plate-type sealings

are used with the following products:

- 1 TUB – flush with the floor shower base
- 2 ELEMENT-VK – plate-type composite sealing
- 3 DRY-ASK – sealing filler for sealing in the sealing tapes
- 4 DRY-DBV – sealing tape for transitions
- 5 DRY-DBVIE – sealing tape as a shaped part “inner corner”

This wall structure also acts as a **vapour barrier**
(sd value approx. 85 m)



Processing tips

■ Storage and transport

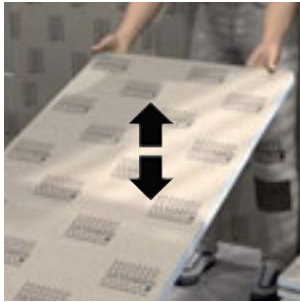

All hard foam support elements must be stored lying down straight in a dry place. Should a construction panel be slightly warped due to improper storage or other reasons, it can usually be straightened by light bending and pressing.



Carrying of the panels in bent condition is recommended, whereby the slit side should face inwards.

■ Laying and screwing

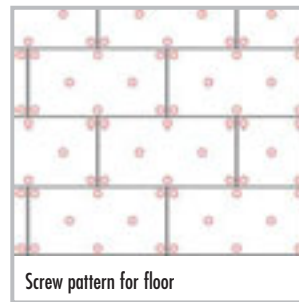
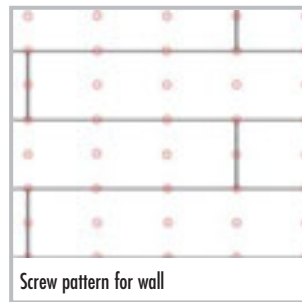
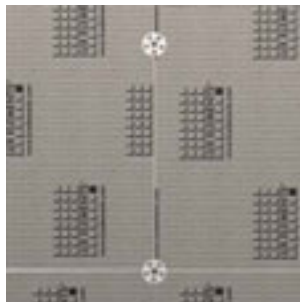

The ELEMENT construction panels are laid in groups; diagonal joints are not allowed.

■ Fixing and gluing



Before applying the adhesive in dots, pierce the holes for the dowels with a cross slot screwdriver.



If ELEMENT-EL Baby 4 is used, **always** apply the fixing adhesive COL-AK over the full surface using a toothed trowel.

■ Optimal edge gluing

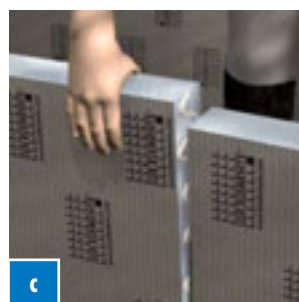
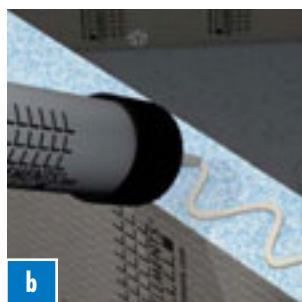

If an absolutely even gluing surface is required, the edges of the hard foam support element should first be ground. For this, use an emery board. Hard foam support elements are glued to one another using COL-MK. The adhesive is applied in a snake-shaped pattern to the edges of the panels. To achieve optimal adhesive distribution, the construction panels are rubbed against one another slightly when placed together.

■ **Easy fastening – for light loads on tiles**

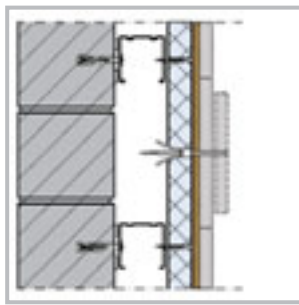

e.g. for a combination stud frame/tile
Drilling the tile for the use of a suitable cavity dowel.

■ **Easy fastening – for light loads on mosaic**

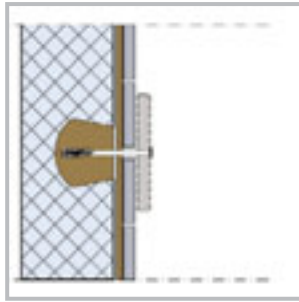

e.g. for a combination of full material/mosaic
Cut the hard foam support material with a cutter, scratch out the hard foam, fill with COL-AK, anchor the mounting setlater in COL-AK.

■ **Fastenings – for higher load accommodation**

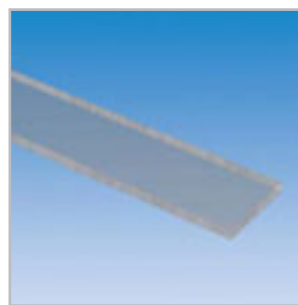
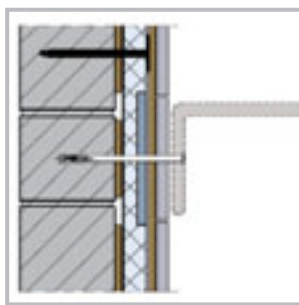

e.g. combination of solid material with FIX-PRO-MAK
Hard plastic insert, which is glued onto the hard foam orebedded into it.

■ **Installation of wall sockets, cable and pipe installation**

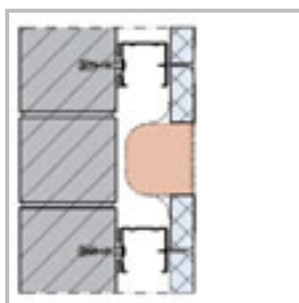

e.g. cavity socket in support construction
Drill a hole in the ELEMENT with a core drill.

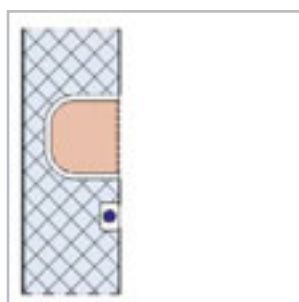

e.g. cavity socket (or lead) in solid material
Cut in parallel into the hard foam support elements, cutters or angle grinders (Flex) with a diamond wheel can be used for slitting: Remove hard foam with suitable tools (e.g. screwdriver or wire brush) as far as necessary, lay and level out with COL-AK.

Design

Alternative surfaces

The construction panel as the substrate for wall, floor and constructions requires an attractive surface. Only then does it have the individual design that can hardly be realised so quickly, easily and cleanly by any other building material combination. The individual form due to the substrate ELEMENT and the surface design by ceramics or plasters turn any bathroom into something unique.

The proven method

In the bathroom and in wet areas of wellness installations you usually find the proven ceramic coverings. This is not surprising, as tiles offer such versatile design possibilities by using decors, colours and glazing options. They are also robust and protect the wall beneath them from moisture.

Ceramic tiles and panels are:

- Beneficial to health and therefore ideal for allergy sufferers
- Antistatic
- Not combustible
- Easy to clean and hygienic
- Non-fading and colour-fast
- Durable and hard-wearing
- Environmentally compatible

ELEMENT construction panels are the ideal substrate for tiles, because they offer optimum hold for cement-based adhesives and seals. Even more advantages of the hard foam support elements in systems with ceramics:

- Emission-neutral, i.e. no vapours that are detrimental to health
- No subsequent affect on ambient air
- Without solvents
- Neutral in smell
- Resistant to mould

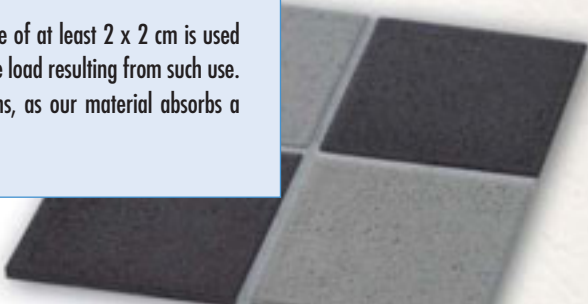

NOTE:

In case of horizontal application we recommend that a size of at least 2 x 2 cm is used for wheelchairs or walking frames, due to the high pressure load resulting from such use. Mosaic can be used in conventional household applications, as our material absorbs a pressure load of at least 0,1 N/mm².



ill. SEMCO



ill. SEMCO



The alternative

Why not try something different? Plasters and decor plasters are becoming increasingly popular for surface design in bathrooms and wellness areas – frequently in combination with tiles. Hence, not only additional room for design is created, but also the application is possible e.g. where tiles or mosaic cannot be installed due to curves.

The construction panel ELEMENT is also the right substrate for plasters, as the mortar coating offers reliable adhesion.

Our products are tested in systems by renowned plaster manufacturers. We will be pleased to provide further information or to recommend a manufacturer. Talk to us!

Whether on the wall, for constructions, in the shower area or on the floor – the construction panel ELEMENT is the right substrate anywhere. Not only for large-sized ceramics and mosaic tiles, but also for plasters.



NOTE:

For further information, please refer to our documents. Data sheets, test certificates and processing instructions can be downloaded from www.luxelements.com



LUX ELEMENTS – The Construction Designing with hard foam support elements



Design

Light fascination

Light is an important design element. It creates a comfortable atmosphere and can bring forward positive feelings. In the wellness field, light and colour aspects play an important role and are sometimes even of therapeutic significance. And in the bathroom, light accents can give the room a wonderful radiance. The easy processability of the hard foam support elements from LUX ELEMENTS enables the trouble-free installation of the most various light systems. The only condition: the continuous temperature should not exceed 75° C.

We therefore recommend light technology with low heat development. Glass-fibre light technology or LED lamps are particularly well suitable. Both systems can be installed in the hard foam support elements without any problems. Whether mounted on the ceiling, floor or wall – the versatility of application options knows no limits.

If you would like to learn more about this topic, please contact our technical department. We will be happy to provide further assistance!

The ideal addition: Tileable shower bases for every bathroom

A modern bathroom usually includes a barrier-free shower. In the product group TUB, LUX ELEMENTS has a wide range of flush with the floor, tileable shower bases. These include not only models with point drainage, but also with channel drain in many shapes and sizes, suitable for any installation situation, for example as a replacement for an old bath tub.

We will be only too pleased to inform you about the possibilities offered by hard foam support elements. Request our product range brochure. Just use the fax order form overleaf.

Thank you for your interest in LUX ELEMENTS products!





+49 (0) 21 71 / 72 12 10

Fax order form

Order more information

(Please enter the quantity and desired language!)

- | | | |
|--|--|-------------------|
| ■ PRICE LIST (D/GB/F/NL) | <input type="checkbox"/> ___ pcs. / <input type="checkbox"/> PDF (E-Mail) | |
| ■ PROGRAM | <input type="checkbox"/> ___ pcs. / <input type="checkbox"/> PDF (E-Mail) | (D) (F) (NL) (GB) |
| ■ THE CONSTRUCTION – Designing with hard foam support elements | <input type="checkbox"/> ___ pcs. / <input type="checkbox"/> PDF (E-Mail) | (D) (F) (NL) (GB) |
| ■ THE EXPERIENCE – Shower bases | <input type="checkbox"/> ___ pcs. / <input type="checkbox"/> PDF (E-Mail) | (D) (F) (NL) (GB) |
| ■ INDIVIDUAL CONCEPTS – Customised and special products | <input type="checkbox"/> ___ pcs. / <input type="checkbox"/> PDF (E-Mail) | (D) (F) (NL) (GB) |
| ■ DETAILED DESCRIPTIVE LITERATURE | <input type="checkbox"/> ___ pcs. | (D) (F) (NL) (GB) |
| ■ ADVICE | <input type="checkbox"/> Yes, I am interested in an appointment, please call me. | |

SECTOR: Architect Tile retailer Tile installer Building materials retailer
 Plumber Bathroom designer Installer Others

COMPANY: _____

CONTACT: _____

ADDRESS: _____

POSTAL CODE/TOWN: _____

TEL: _____

FAX: _____

E-MAIL: _____



The EUF (European Union of National Tile Associations) has developed the concept "Healthier Living with Ceramics" together with its European member associations and sponsor members. This concept is intended as information "pro tile" for trade, dealers and manufacturers. LUX ELEMENTS is the force behind the project and is actively involved in its implementation.

(D)

LUX ELEMENTS GmbH & Co. KG
 An der Schusterinsel 7 · D - 51379 Leverkusen
 Tel. +49 (0)21 71/7212-0
 Fax +49 (0)21 71/7212-10
 E-Mail info@luxelements.de
 Web www.luxelements.com

(F)

LUX ELEMENTS S.A.S
 31, rue d'Ensisheim · F - 68190 Ungersheim
 Tél. +33 (0) 3 89 83 69 79
 Fax +33 (0) 3 89 48 83 27
 E-Mail info@luxelements.fr
 Web www.luxelements.fr

UK Sales Manager Christopher Smith
 Tel. 07896-888084
 E-Mail c.smith@luxelements.co.uk

CONSTRUCTION · GB-2/2013
 We reserve the right to make technical changes.